



GM2000HPS II

EQUATORIAL GERMAN MOUNT

ULTRAPORTABLE VERSION

Instruction and Maintenance User's Manual



Firmware version 2.14

This manual is protected by international copyright laws.

All rights are reserved. Total or partial reproduction of this manual is forbidden.

Copyright 2016 Comec costruzioni meccaniche snc – Italy.

Parts of this manual are translated from a manual in German language created by Helmut Heinicke, Nersingen.

Table of Contents

1 Foreword	7
1.1 Aim of this Manual	7
1.2 Ownership and Importance of this Manual	7
1.3 Updating of this Manual	7
2 Technical Data	8
3 Introduction	9
4 Mount Setup	10
4.1 Standard Configuration Items	10
4.2 Required Tools	11
4.3 Packaging and Handling	11
4.4 Mount Parts Identification	13
4.5 Assembling the Base Adapter	14
4.6 Attaching the mount to the Centaurus Tripod version 2 (optional)	14
4.7 Attaching the Mount to a Pier	14
4.8 Assembling the Mount	17
4.9 Rough Altitude Adjustment	17
4.10 Mounting the Counterweights and the Telescope	19
4.10.1 Mounting the Counterweights	19
4.10.2 Mounting the Telescope	21
4.11 Balancing the Telescope	21
4.12 Clutches	22
4.13 Orthogonality of the telescope	23
4.14 Fine Altitude and Azimuth Adjustment	23
5 The Control Unit	25
5.1 The Connection Panel	25
5.1.1 GPS Connector	26
5.1.2 Autoguider Input	26
5.1.3 Ethernet – LAN Connector	27
5.1.4 Remote Power Switch Connector	27
5.2 Electrical Setup	28
5.2.1 Power Supply	29
5.2.2 Clock battery	30
5.3 The Keypad	31
5.3.1 Learning to Use the Keypad	32
5.3.2 The Direction Keys	34
5.3.3 The Numeric Keys	35
5.3.4 The MORE Key	35
5.3.5 The STOP Key	35
5.4 First Startup	35
5.4.1 Clearing a previous alignment	36
5.4.2 Setting the Local Data	36
If you are using the GPS module:	36
If you want to choose a city from the database:	36
If you want to enter location data manually:	37

5.4.3	Setting the Refraction Parameters	37
5.5	Alignment	38
5.5.1	Two-stars Alignment	38
5.5.2	Three-stars Alignment	39
5.5.3	Alignment refinement	39
5.5.4	Aligning the Polar Axis with the Polar Align function	39
5.5.5	Iterative Alignment of the Polar Axis	40
5.5.6	Correcting the Orthogonality Error	40
5.5.7	Visualisation of the Alignment Information	41
5.5.8	Alignment Procedures	41
	Simple three-star alignment (not suitable for astrophotography use)	41
	Polar alignment using the mount model	42
	Polar iterate alignment	42
5.6	Notes on autoguiding	43
5.7	Parking the Mount	43
5.8	Switching off the Mount	44
6	The Menu System	45
6.1	The Object Menu	45
6.1.1	Deepsky	45
6.1.2	Star	46
6.1.3	Planet	47
6.1.4	Moon feature	47
6.1.5	Asteroid	48
6.1.6	Comet	48
6.1.7	Coordinates	48
6.1.8	User Defined	48
6.1.9	Alt/Az Coords	49
6.1.10	Meridian Flip	49
6.1.11	Satellite	49
6.2	The Alignment Menu	50
6.2.1	Park/Unpark	50
6.2.2	Park Position	50
6.2.3	Polar Iterate	50
6.2.4	2-Stars	50
6.2.5	Refine Stars	51
6.2.6	3-Stars	51
6.2.7	Delete star	51
6.2.8	Align Database	51
6.2.9	Clear align	51
6.2.10	Polar Align	51
6.2.11	Ortho Align	51
6.2.12	Align Info	52
6.2.13	Sync Refines	52
6.2.14	Boot Align	52
6.3	The Drive Menu	52
6.3.1	Tracking Speed	52
6.3.2	Dual tracking	53
6.3.3	Swap E – W	53

6.3.4	Swap $N - S$	53
6.3.5	Auto Swap $N - S$	53
6.3.6	Corr. Speed	53
6.3.7	Slew Rate	53
6.3.8	Autoguide speed	53
6.3.9	Tracking corr.	54
6.3.10	Flip Slew Tol.	54
6.3.11	Flip Guide Tol.	54
6.3.12	Horizon Limit	54
6.3.13	Track warn.	54
6.3.14	Follow Obj.	54
6.3.15	Balance	54
6.3.16	Meridian side	55
6.3.17	Preheating	56
6.3.18	Dithering	56
6.4	Local Data	56
6.4.1	Clock	57
6.4.2	Site	57
6.4.3	Use GPS Data	57
6.4.4	Boot GPS Sync	58
6.4.5	GPS-UTC diff	58
6.4.6	Refraction	58
6.5	Settings	58
6.5.1	User Interface	58
6.5.2	GPS Port	59
6.5.3	Emulation	59
6.5.4	Network	59
6.5.5	Wireless	60
6.5.6	Asteroid Filter	61
6.5.7	Comet Filter	61
6.5.8	Shutdown	61
6.5.9	Dome	61
6.5.10	Version	62
6.5.11	Language	62
6.5.12	Security	63
7	Additional Functions	65
7.1	Countdown Timer	65
7.2	Stop Watch	65
7.3	Dithering control	65
8	Alignment Stars	66
8.1	List of Reference Stars Sorted by Constellation	66
8.2	List of Reference Stars Sorted by Name	67
8.3	Alignment Star Charts	69
8.3.1	Northern Hemisphere Chart – March to May	70
8.3.2	Northern Hemisphere Chart – June to August	71
8.3.3	Northern Hemisphere Chart – September to November	72
8.3.4	Northern Hemisphere Chart – December to February	73
8.3.5	Southern Hemisphere Chart – March to May	74

8.3.6	Southern Hemisphere Chart – June to August	75
8.3.7	Southern Hemisphere Chart – September to November	76
8.3.8	Southern Hemisphere Chart – December to February	77
9	Remote Control	78
9.1	Configuration	78
9.1.1	RS-232 Serial Connection	78
9.1.2	Ethernet or Wireless LAN	78
9.2	Controlling the Mount with the Virtual Keypad	80
9.2.1	Operation	80
9.3	Controlling the Mount with Other Software	81
9.3.1	Installing and Using the 10micron ASCOM Driver	82
	Communication	82
	Mount Settings	83
	Optics Settings	83
9.4	Notes for some Software Packages	83
9.4.1	Note for "TheSkyX"	83
9.4.2	Note for "Perseus"	83
9.4.3	Note for "Sky Safari" on Android or iOS	84
9.5	Upgrading the Firmware	84
10	Troubleshooting	85
11	Maintenance	87
12	Technical Support Centre	88
13	Menu Structure	90
13.1	Objects	90
13.2	Alignment	92
13.3	Drive	94
13.4	Local Data	96
13.5	Settings	97
14	Technical Drawings	99
14.1	Base Adapter	99
14.2	Tripod Adapter (optional)	100
14.3	Telescope Flange	101

1 Foreword

1.1 Aim of this Manual

In accordance with the provisions of the European Machinery Directive 89/392/EEC, as amended by 91/368/EEC and 93/44/EEC, and of Directive 89/833/EEC, our company has developed this instruction and maintenance manual, in order to inform all users about the product, the correct methods of interaction with the machinery, in order to guarantee optimum safety conditions for people, animals and things, during its entire life cycle: transport, storage, installation, usage and maintenance.

1.2 Ownership and Importance of this Manual

This manual is an integral part of the machine. We therefore advise users to keep it in a safe place for the foreseeable duration of the product itself. It is the client's responsibility to transfer this manual to possible subsequent owners of the machine, or to any one else who will possess or make use of the machine.

1.3 Updating of this Manual

In the event of improvements and/or corrections being made to the machine, either by the manufacturer or by the client, subject to written authorisation by the manufacturer, it might be necessary to also update the documentation of the manual. Our company will evaluate this necessity, case by case, and will dispatch the modified parts of the manual. Our company will also indicate, by sending updates, all the sections of the manual to be disposed of, specifying the dates of validity of the modifications and the revision number of the manual's edition. The receiver is obliged to comply scrupulously with the provisions stipulated by the manufacturer in order to ensure that all copies of the manual, distributed within the company, are updated to the latest edition. It is strictly forbidden to make changes of any nature or any type whatsoever, to the contents, the graphic layout and the structure of the manual.

Furthermore, our company reserves the right to improve the product through modifications even though they may not be described in this edition of the manual.

Furthermore, our company also reserves the right to change or update this manual.

2 Technical Data

Weight	18.5kg (r.a. body) + 15kg (dec. body) without accessories
Instrument payload capacity	~ 50kg
Latitude range	20° – 70° adjustable with screw
Azimuth fine adjustment range	+/- 10° adjustable with double screws
Counterweight shaft	40mm diameter stainless steel, weight 4kg
Counterweights (optional)	6kg or 12kg each, stainless steel
Axes diameter	50mm
Material	alloy steel
Bearings	pre-loaded tapered roller bearings
Worm wheels	215 teeth, 172mm diameter, bronze B14
Worm	24mm diameter, tempered alloy steel, grinded and lapped
Transmission system	backlash-free system with belt and automatic backlash recovery
Motors	2 axes A.C. servo brushless
Feedback system	High resolution absolute encoders (both axes)
Power supply	24VDC
Power consumption	~ 0.7A while tracking ~ 3A at maximum speed ~ 5A peak
Guide speed	Adjustable from 0.1x to 1x
Go-to speed	20°/s max.
Pointing accuracy	< 20" with internal multiple-stars software mapping
Average tracking accuracy	< +/- 1" typical for 15 minutes (< 0.7" RMS)
Software security stop	+/- 30° past meridian in r.a.
Mechanical security stop	+/- 45° past meridian in r.a.
Operating temperature range	- 15 °C ... + 35 °C
Storage temperature range	- 40 °C ... + 50 °C

3 Introduction

The GM2000HPS II German equatorial mount has been designed to meet the needs of the advanced observer who requires a mount with maximum strength and accuracy, for the most demanding photographic applications. The GM2000HPS II is the perfect mount for medium-sized instruments such as 150mm refractors, 250mm Newtonian reflectors, 330mm Cassegrains.

Born from the needs and experience of astronomers, inspired from the traditional German form, the GM2000HPS II mount has been designed completely in Italy with innovative technologies, such as 3D-CAD models and CAM, and manufactured using modern CNC machine tools with high precision, carved out from aluminium bar-stock.

In order to provide the maximum pointing and tracking accuracy, the GM2000HPS II integrates proprietary absolute high-resolution encoders on both axes.

The control system, motor and electronics, have been designed without compromises, aiming for the best performance, flexibility and connectivity, to satisfy the needs of the 21st century observatory.

All this is a warranty of success.

In order to maximise your pleasure on your first night of observation, we recommend that you familiarise yourself with the assembly and basic operation of the mount.

Look at the illustrations and read the manual.

Please take particular note of balancing, operation of the keypad controller and this caution:



DANGER

Never look at the Sun with a telescope or finderscope without installing a proper and secure solar filter. Looking at the Sun without a secure solar filter compromises the eye instantaneously and without remedy. Before looking at the Sun it is necessary to install securely a proper solar filter. Don't use filters mounted at the eyepiece. Optics could be damaged by the excessive heat, and some filters can break! Never use your telescope/mount system to project an image of the sun onto any surface; internal heat build-up can damage the telescope. Particular attention is required when observing in daytime without filter (Venus, for example). Never look through the telescope or the finder when the mount is slewing. Never look at an object too near to the Sun. Never leave unattended your telescope if it is able to point at the Sun. Never leave the telescope system unsupervised, when unauthorised persons or children are present.

GOOD OBSERVATIONS TO YOU.

4 Mount Setup

4.1 Standard Configuration Items



Fig. 4.1: Standard configuration items.

Ordering a GM2000HPS II in the standard configuration you receive the following items:

1. equatorial mount GM2000HPS II (assembled) (x1);
2. base adapter (x1);
3. azimuth adjustment block (x1);
4. azimuth adjustment block screws (x2);
5. base adapter screws (x4);
6. mount locking knobs (x4);
7. counterweight shaft (x1);
8. control box with padded bag (x1);
9. keypad (x1);
10. cross-wired LAN cable 5m (x1);
11. mount connection cable (x1);
12. power supply cable (x1);
13. remote switch cable (x1);
14. CD-ROM with maintenance and instruction manual and software (x1).

When you receive your new GM2000HPS II mount, pay attention to check that no part has been

damaged during shipment; damaged parts may not work correctly and may damage the system.

This equipment must be considered like a **precision instrument!**

4.2 Required Tools

In order to assembly your mount and make the necessary adjustments, you need the following tools:



hex (Allen) screwdrivers in the following sizes: 3mm – 4mm – 5mm – 6mm

4.3 Packaging and Handling

Whenever you ship the mount, use the original packaging made in ethafoam and cardboard (Fig. 4.2). Pick up the mount as shown in Fig. 4.3.



Fig. 4.2: GM2000HPS II package.

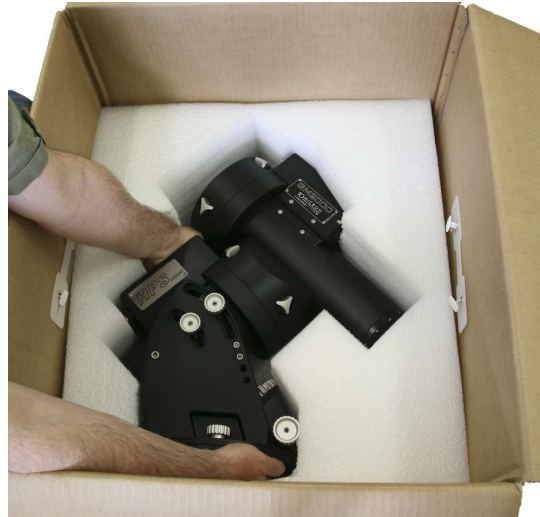

Fig. 4.3: Picking up the mount.

As an optional, we can provide flycases that can be used for transport (Fig. 4.4).

The mount must be shipped with the clutches unlocked. Do not move the mount with any counterweight or telescope mounted.



Fig. 4.4: Flycase for the GM2000HPS II(ultraportable version).

4.4 Mount Parts Identification

See Fig. 4.5 to identify the relevant parts of your GM2000HPS II mount.

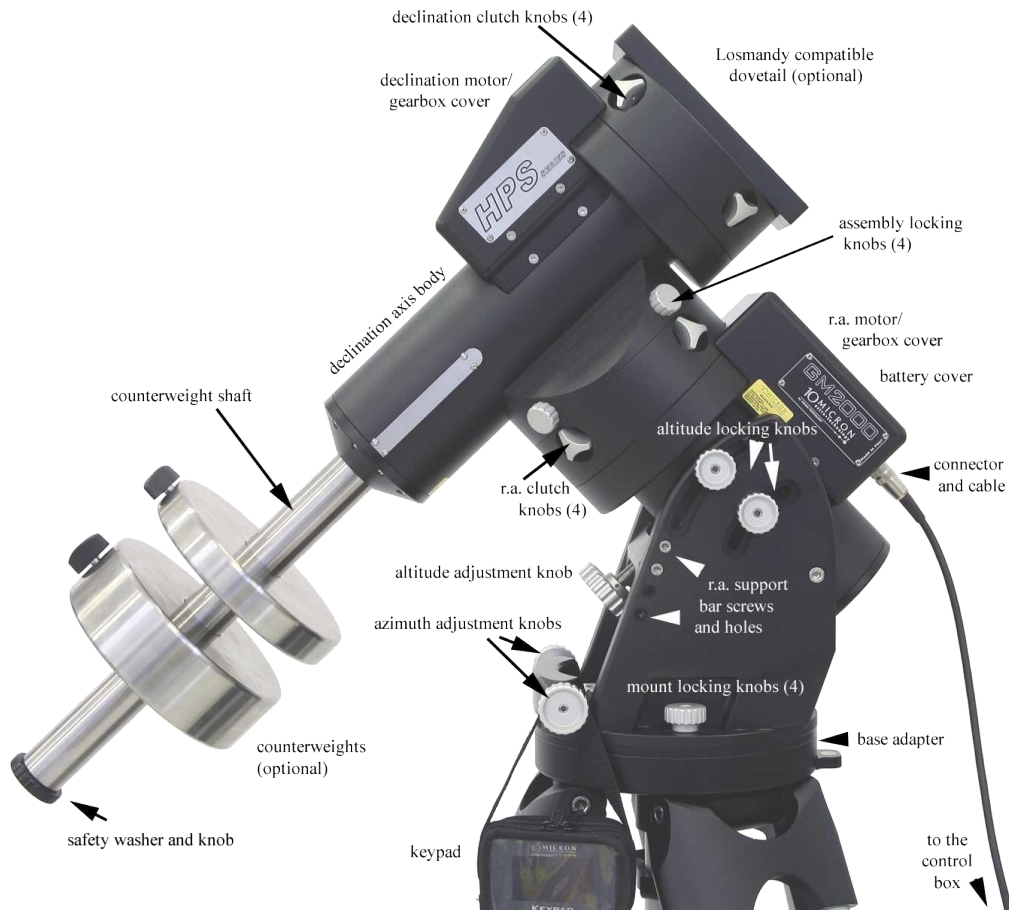

Fig. 4.5: GM2000HPS II mount parts.

4.5 Assembling the Base Adapter

Assembly the azimuth adjustment block with the base adapter using the provided screws (Fig. 4.6).



Fig. 4.6: Base adapter assembly.

4.6 Attaching the mount to the Centaurus Tripod version 2 (optional)

The Centaurus Tripod version 2 is an extremely stable tripod manufactured by 10Micron. The Centaurus is supplied already assembled.

Adjust the legs until the tripod has roughly the desired height (Fig. 4.7). Put the tripod in place. One of the legs should point as exactly as possible northward (southward if you are in the southern hemisphere).

The legs are equipped with three levelling screws and anti-vibrating and anti-sinking pads (Fig. 4.8); the levelling screws can be used to adjust the tilt of the tripod with the assistance of two bubble levels.

Use the enclosed four screws to attach the base adapter to the tripod as in Fig. 4.9, paying attention to put the azimuth reference northward (southward if you are in the southern hemisphere).

Now the mount can be put on the base adapter and fastened with the four knobs (Fig. 4.11).

The tripod provides three hooks where the control box and the keypad may be hung (Fig. 4.10).

4.7 Attaching the Mount to a Pier

The GM2000HPS II can be mounted on a pier by means of the base adapter (Fig. 4.12). The pier's top must be machined in order to provide a suitable housing for the base adapter, keeping the correct orientation – the protruding block (1) of the base adapter is used for azimuth alignment and should be oriented towards the celestial pole (i.e. towards north if you are in the northern hemisphere, and towards south if you are in the southern hemisphere). Please refer to the base adapter technical drawing in 14.1. The base adapter has to be screwed to the pier using four bolts (2).



Fig. 4.7: Legs adjustment system.



Fig. 4.8: Tripod leg base.



Fig. 4.9: Tripod with base adapter.



Fig. 4.10: Tripod hooks.

Instead of machining the pier's top to accommodate the base adapter, you can use the optional pier adapter (Fig. 4.13). In this case, the flat top of the pier should accommodate the four bolts used to fix the pier adapter to the pier; then you can mount the base adapter on the pier adapter.

Please refer to the pier adapter technical drawing in 14.2.

After locking the base adapter, put the mount on it paying attention to align the azimuth adjustment screws on the mount with the protruding block on the base adapter. Then lock the four knobs holding the mount to the base adapter.



Fig. 4.11: Mount on base adapter.



Fig. 4.12: Base adapter.



Fig. 4.13: Pier adapter (optional).

4.8 Assembling the Mount

The GM2000HPS II ultraportable mount comes in two parts that can be easily assembled and disassembled in the field. To assemble the mount, first attach the r.a. body part to the tripod or pier. Check that the r.a. axis is oriented as shown in Fig. 4.14, with the white marks matching. Then attach the declination body part paying attention that the holes in the declination body part match the protruding cylinders in the r.a. body part, as well as the electrical connector (Fig. 4.15). Then tighten firmly the assembly locking knobs (see Fig. 4.5).



Fig. 4.14: Put the r.a. axis in this position before assembling the mount.



Fig. 4.15: Ultraportable version assembly.

To disassemble the mount, make sure that no telescope or counterweight is attached, then loosen completely the assembly locking knobs and remove the declination body part.

4.9 Rough Altitude Adjustment

The altitude of the R.A. axis must match the latitude of your observing site. Refer to Fig. 4.17 for locating all the relevant parts of the mount.

We recommend that you do the rough altitude adjustment before mounting the counterweights and the telescope, since you will be making major adjustments to the position of the mount at this time. The telescope and the counterweights would add considerable weight and require more effort.



Fig. 4.16: The support bar.

The support bar is shown in Fig. 4.16. It must be assembled in the appropriate position using two holes. The hole marked as A will be always used and must correspond to one of the holes on the mount marked as 1 – 4 in Fig. 4.17, depending on the latitude range desired. Also one of the holes marked as B, C, D, E will be used according to the following table:

Latitude	Position
from 54° to 70°	Match holes A–4, match holes E–3
from 43.5° to 61°	Match holes A–3, match holes D–4
from 33° to 48°	Match holes A–2, match holes C–1
from 20° to 37°	Match holes A–1, match holes B–2

In the picture the support bar is assembled for the latitude range from 43.5° to 61°.

In order to change the position of the support bar the following procedure should be applied:

1. make sure that no instrument nor counterweights are mounted;
2. loosen about one turn the four altitude locking knobs (5) supporting the R.A. axis body;
3. locate the R.A. axis body high enough to leave some space to put the support bar in the correct position and lock the four altitude locking knobs;
4. loosen and remove the four screws holding the support bar;
5. move the bar in the new position and insert the four screws, without tightening them;
6. above 23° of latitude, put the brass disk (4) between the altitude screw and the R.A. axis body, so that the altitude screw (3) is orthogonal to the plane under the R.A. axis body. Between 20° and 23° remove the brass disk. Turn the the altitude screw until the disk touches the R.A. axis body;
7. unlock the four altitude locking knobs so that the R.A. axis body rests on the brass disk;



Fig. 4.17: Altitude adjustment system.

8. lock the four screws holding the support bar;
9. lock the four altitude locking knobs.

Later, you will do your final polar alignment with the telescope and counterweights.

4.10 Mounting the Counterweights and the Telescope

Before mounting the counterweights and the telescope, ensure that the mount is in the safety position shown in Fig. 4.18, with the declination axis oriented so that the counterweight shaft points downward. It is essential that the r.a. and declination axes are oriented as shown in the picture; the white marks must coincide on both axes, and the telescope must be mounted looking at the celestial pole.



WARNING

Mounting the counterweights or the telescope when the declination axis is not in the safety position can cause sudden movement of an unbalanced load, possibly causing damage and injury.

4.10.1 Mounting the Counterweights

Optional counterweights (Fig. 4.19) can be ordered from 10micron. Check the website www.10micron.com or ask the reseller for availability.

Mounting the counterweight shaft is very easy (Fig. 4.20). Insert the threaded end into the hole in the declination axis, then rotate it clockwise until it is firmly blocked.

Remove the safety washer and knob from the end of the counterweight shaft. Insert an amount of counterweights at least equal to the weight of the telescope and accessories you are going to use.



Fig. 4.18: This is the position to attach the counterweights and the telescope.



Fig. 4.19: 6kg counterweight and 12kg counterweight.

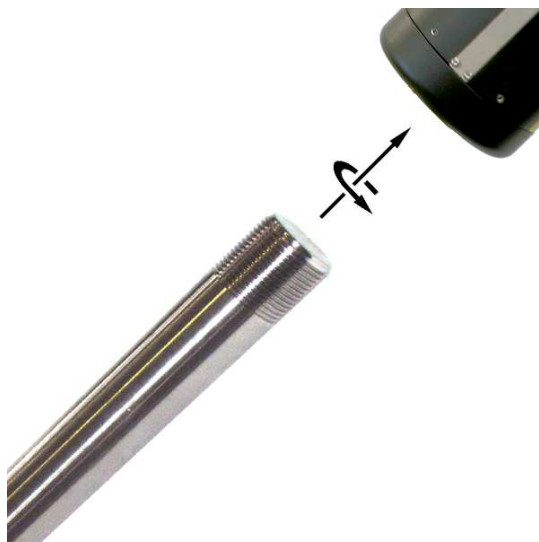

Fig. 4.20: Counterweight shaft thread.



Fig. 4.21: Safety washer and screw.

Lock firmly the blocking screw of each counterweight. Remember to put back the safety washer and knob when you have finished (Fig. 4.21).

**WARNING**

Counterweights are heavy; you must pay attention during handling to avoid injury. Never forget that they can fall on your feet and hurt you! Damage can result to the equipment also if the declination axis is moved from the safety position with counterweights mounted but without telescope mounted on the other side. After mounting the counterweights, proceed to mount the telescope before moving the mount.

4.10.2 Mounting the Telescope

The telescope mounting flange on the declination axis can accommodate a great variety of supporting systems. You can adapt your support using the technical drawing in 14.3 for all holes measure details, or use a dovetail plate.

10micron supplies various optional dovetail plates, see Fig. 4.22 and Fig. 5.7; also refer to the website www.10micron.com.



Fig. 4.22: LOSMANDY plate.



Fig. 4.23: MAXI plate.

4.11 Balancing the Telescope

Balancing the telescope is important to ensure optimal operation of the mount. If the system is not correctly balanced, pointing accuracy may suffer and the motors can lock.

Follow the procedure closely to balance the GM2000HPS II mount.

1. Check the position of the counterweight shaft and counterweights: they must to be in the safety position of Fig. 4.18, with counterweights in excess. The safety position ensures that even if the telescope is not correctly balanced the mount is in an equilibrium position. This is important to avoid stress and damage to the gears; furthermore, if the worm gear is unhooked when the mount is not in equilibrium, the sudden movement can damage to the mount itself or cause injury.
2. Tighten the four R.A. axis clutch knobs.
3. Loosen the four declination axis clutch knobs so that the telescope moves freely about the declination axis. Be careful because if your telescope is significantly out of balance, it may swing quickly in one direction!
4. Loosen the tube mounting rings and slide the tube up and down for balancing. The scope is balanced when it does not move with the clutch knobs loose and the movement back and forth about the declination axis has the same feel in both directions.
5. Tighten the declination axis clutch knobs
6. Loosen the R.A. axis clutch knobs and move the telescope so the counterweight shaft is horizontal. Again be careful if your telescope is significantly out of balance.
7. Loosen the counterweight blocking screw(s) and move the counterweight(s) up or down along the shaft to achieve balancing. Again, the scope is balanced when it does not move with the clutch knobs loose and the movement back and forth about the R.A. axis has the same feel in both directions. Remember to tighten again the blocking screw(s) when the scope is balanced.
8. Tighten the R.A. axis clutch knobs.

Try to anticipate any balance problems due to the extra weight of diagonals, eyepieces, filters, finders, cameras etc. It is advisable to do the balancing with your “typical” accessories in place.



NOTICE

The mount can tolerate small error of balancing, but do not exceed to avoid damages.

You may balance the mount using also an alternative procedure based on torque reading from the motors. See paragraph 6.3.15 for details.

4.12 Clutches

The clutches allow the telescope to move by hand. Furthermore, they work as a protection system for the mechanics, allowing the axes to slip when an excessive force pushes on the telescope. When pushing the telescope by hand, it is normal behaviour to have the clutches slip, even if they are tightened. Since the mount features absolute encoders on both axes, this doesn't harm the accuracy of the mount in any way.

The correct way of tightening the clutch is to start tightening a pair of handles in opposition, then tightening the other pair. Finally, tighten further the handles one by one.

**WARNING**

Do not tighten the clutches too much. When the clutches are too tight, the tracking performances of the mount may be degraded.

If the temperature falls while observing, it is possible that the clutches become difficult to unlock. In this case, it is possible to use the optional clutch handle shown in fig. 4.24.



Fig. 4.24: Additional handle for clutches unlocking (optional).

4.13 Orthogonality of the telescope

Ideally, the telescope optical axis should be orthogonal to the declination axis. A telescope is not orthogonal if the optics are pointing to an angle other than exactly 90° to the declination axis. While our mount's axes are very accurately machined and very close to being perfectly orthogonal, the telescope optical axis can be significantly misaligned. This could be due to improperly machined rings, wedge in the cradle plate, optical axis not parallel to the mechanical axis of the tube assembly.

Whatever the reason, orthogonality can be easily checked and adjusted if needed. The software of the mount can measure the orthogonality error (also called “cone error”) and help you to correct it.

You can attain a good polar alignment even with a residual orthogonality error; furthermore the orthogonality error is not a cause of drift or field rotation, so correcting it is not strictly necessary.

4.14 Fine Altitude and Azimuth Adjustment

The fine altitude and azimuth adjustment procedure must be performed with the help of the mount software in order to obtain a good polar alignment. The software provides various polar alignment routines that will assist you in this step; these are described in paragraph 5.5.

Please refer to Fig. 4.25 for locating the relevant parts of the mount. The procedure to make the mechanical adjustments is the following:

1. Loosen the four altitude locking knobs (1) about a half turn.
2. Loosen about a half turn the four knobs holding the mount to the base (2).
3. Adjust the altitude moving the R.A. body up or down with the altitude screw (3).
4. Adjust the azimuth moving the mount left or right using the two azimuth screws (4); you must back off the opposing azimuth screw in order to move the other screw in that direction.
5. When you have reached the final position, lock the four altitude locking knobs and the knobs holding the mount to the base.



Fig. 4.25: Fine altitude and azimuth adjustment system.

5 The Control Unit

All electronics and electric connections are integrated in a box. The control system includes also:

1. an ergonomic keypad with 2m spiral cable and a 12-pin circular connector with security lock ring;
2. a red-black cable for power supply with a 2-pin circular connector with security ring;
3. a cable for connecting the mount to the control box.



WARNING

All connections should be made before connecting the power supply of the mount, to avoid the risk of damaging the electronics. The LAN connection makes exception to this and can be plugged in or out while the mount is switched on. Also don't undervalue the risk of electric shocks, even if the system is operated at 24VDC. Keep the control box clear of dew and water.

5.1 The Connection Panel

All the electronic connections are accessible from the connection panel on the control box.



Fig. 5.1: The connection panel on the control box.

1. Main protection fuse (3.15A)
2. Power LED (red)
3. Power switch
4. Circular 12-pin keypad connector (marked HAND PAD)
5. Circular 16-pin mount connector
6. RS-232 serial, DB-9 connector for remote PC control
7. Ethernet-LAN RJ-45 connector for remote PC control
8. Connection for external on/off switching with relay box, 3.5mm stereo jack
9. Power supply connector (24VDC, 4A)

10. Circular 4-pin auxiliary connector
11. Autoguide connector, 6-pin RJ12 (6/6)
12. Connector for GPS module (optional), or RS-232 for remote PC control, 4-pin RJ11 (4/4)

5.1.1 GPS/RS-232 Connector



Fig. 5.2: The optional GPS module.

The GPS/RS-232 socket can be used with the optional GPS module (Fig. 5.2) to retrieve the coordinates of the observation site and the exact universal time.

The port is a 4-pin RJ11 (4/4) with the pinout shown in Fig. 5.3.

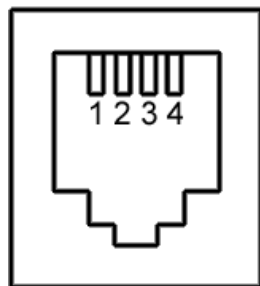

1. receive data (RX)
2. +5V supply
3. ground
4. transmit data (TX)

Fig. 5.3: GPS/RS-232 port pinout.

If no GPS module is connected, the socket can be used with the optional adapter (Fig. 5.4) as an RS-232 serial port to control remotely the GM2000HPS II mount from a PC, using software such as “Guide”, “TheSky”, “Cartes du Ciel”, “Perseus” etc. Alternatively you may use this connector to control a Baader Planetarium dome directly from the mount. Please refer to paragraph 6.5.9 for details.

5.1.2 Autoguider Input

This port is a RJ12 (6/6) port (sometimes also marked RJ11-6 or 6p6c) where you can connect a CCD camera or another system for automatic guiding (autoguide). The autoguide input follows the SBIG ST-4 protocol. The correction speed is by default 0.5x the sidereal speed, and can be adjusted to lower speeds (see paragraph 6.3.8). The autoguider input is always active and



Fig. 5.4: GPS to RS-232 adapter (optional).

corrections may be operated on both axes at the same time. The corrections of the autoguide are independent of the direction keys on the keypad.

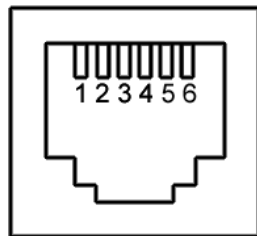

1. not connected
2. ground
3. east
4. south
5. north
6. west

Fig. 5.5: Autoguide port pinout.

The pinout is shown in Fig. 5.5. To move the mount in one of the four directions, the corresponding pin has to be put in contact with the ground pin. The magnitude of the correction is proportional to the duration of the contact.

You can also autoguide through the GPS/RS-232 port using the command protocol.

5.1.3 Ethernet – LAN Connector

This port is a Gigabit Ethernet interface. The mount can be controlled over the network with this port in all its functions. Use a CAT.5 cable to connect to your network, like for a normal Ethernet device. See chapter 9 for details about the remote control.

5.1.4 Remote Power Switch Connector

The GM2000HPS II can be connected to an external relay box in order to switch on and off the system remotely, using the provided 3.5mm stereo jack connector. A suitable jack plug and cable is provided (Fig. 5.6). Only the central contacts are used. They have to be shorted by the relay box like a push-button: to switch on the mount, the contact must be closed for a time interval between one second and two seconds, and then opened. To switch off the mount correctly, you should use another pulse of the same duration. Then wait at least 30 seconds before shutting down the power supply.



Fig. 5.6: Remote switch jack plug and cable.

The jack should be inserted with no power supply connected to the mount.

5.2 Electrical Setup

To operate the GM2000HPS II mount, some electrical connections are needed. Make all connections before attaching the power supply.



WARNING

Prevent the cables from tangling. Position all cables so that they do not tangle even when the mount goes across the meridian during slewing. In addition to the motor and power cables that are provided with the mount, you may have additional cables for other accessories. We suggest that you position your cabling carefully to avoid a tangled mess. When your cables are set up, move the telescope manually throughout the normal range of movement to be sure that the cables do not catch on anything and that you have enough length.

Connect the mount connection cable to the circular connector on the control box and to the connector above the R.A. axis of the mount. To avoid bad connections it is important to lock the threaded rings on both ends of the connector.

Connect the keypad to the control box with its 12 pin circular connector, locking the threaded ring of the connector.

Connecting the keypad is optional if you control the mount remotely from a PC.

Complete all other connections as needed, then you can connect the power supply.



Fig. 5.7: Electrical setup. 1 – control box; 2 – keypad; 3 – mount cable; 4 – power supply cable.



Fig. 5.8: Mount connection cable.



WARNING

Do not connect or disconnect any cable while the electronics is switched on, with the exception of the LAN connector. Otherwise the electronics and the motors may be damaged.

5.2.1 Power Supply

The GM2000HPS II mount requires a 24V DC, 5A regulated power supply. If slewing speeds are limited to 10°/s or less, it is enough to use a 24V DC, 4A power supply. Use the supplied red and black cable to connect the power supply to the 2-pin round plug labelled “POWER SUPPLY” on

the control box. The threaded ring of the connector should be firmly locked.

The red wire must be connected to the positive (+) pole of the power supply, the black wire must be connected to the negative (–) pole.

The protection fuse may be replaced only with another 3.15A slow-burning fuse. Spare fuses are available from ordinary electronic shops. If the power supply is reverse connected the protection fuse may blow, but the electronics will be safe.

The current required by the GM2000HPS II system varies between 0.7A and 4A depending on the motor speed and on the supply voltage. The operating voltage may vary from 24V to 26V. Please don't use unregulated power supplies because the output voltage of these units is not good enough to operate the mount.

When using a voltage of less than 24V the motors can stop; normal operation is not guaranteed. If you want optimal performance, you must use a 24V power supply. Suitable power supplies are available as optional.

5.2.2 Clock battery

The GM2000HPS II has an internal temperature-compensated crystal oscillator which can maintain time within ± 2 minutes per year in the temperature range from -40°C to $+85^{\circ}\text{C}$. This clock is powered by a non-rechargeable 3V lithium CR2032 battery which provides power for several years.

When you need to replace the battery, it may be accessed by unscrewing the battery cover on the top of the r.a. axis. Place the new battery with the positive pole up. Pay attention not to bend the contact of the positive pole below the battery, as shown in 5.9.

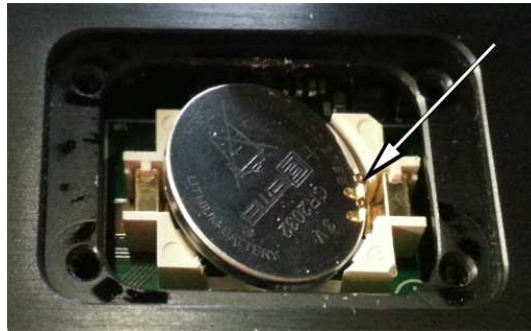

Fig. 5.9: Clock battery replacement.



WARNING

Replace only with another non-rechargeable, 3V lithium CR2032 type battery. Do not use rechargeable batteries.



Fig. 5.10: The keypad.

5.3 The Keypad

The keypad (Fig. 5.10) is a communication interface between the mount and the operator, enabling the control of all the functions of the mount. The keypad features large control keys that can be easily found and pressed with thick gloves and a well-readable 128x64 pixel LCD display that can operate in a wide range of temperature thanks to an heating device (-40° C to +80° C), remaining readable in daylight as well as at night.

If you are using the keypad in the daylight, you may need to shade the screen from the direct sunlight with your hand in order to see it more clearly.

Brightness and contrast can be adjusted as required.

With a few keystrokes, you can slew to objects by their common name or catalogue number, set a countdown timer for a photographic exposure, set the tracking speeds, enter coordinates to find the newest object, adjust the brightness of the display, set parameters and much more.

5.3.1 Learning to Use the Keypad

The first time you switch on the mount you will make some setup procedures in order to ensure correct operation. You will control the mount using the keypad, so it is useful to make yourself comfortable with its mode of operation.

After switching on the mount, the keypad display will show the 10Micron logo. After about a minute, when the mount electronics has completed the initialization, the display will enter the normal status. The first two lines will show the current date and time:

```
21:05:48 DST
2007 May 14
```

while the third and the fourth line will show the current equatorial coordinates.

The two pairs of lines can be configured to show various data views and utility functions. By pressing the **3-DISP** key, you will cycle the top data view, and by pressing the **2-INFO** key, you will cycle the bottom data view.

Some functions are available only for the top data view.

The functions are the following:

Display	Function
R.A./Dec. coordinates	The equatorial coordinates where the telescope is looking
Az./Alt. coordinates	The altazimuth coordinates where the telescope is looking
H/Dec. coordinates	The hour angle and declination coordinates (both in degrees) where the telescope is looking.
Object data	The data of the current object; pressing 2-INFO will cycle between showing the name, type and magnitude of the object; its equatorial coordinates; its altazimuth coordinates.
Countdown timer	A countdown timer (see paragraph 7.1)
Chronometer	A stopwatch timer (see paragraph 7.2)
UTC clock	The current universal time (shows a 'G' letter if the time is currently being synchronized with the GPS module)
Sidereal time and JD	The current sidereal time and Julian date (shows a 'G' letter if the time is currently being synchronized with the GPS module)
Local time clock	The current local time (shows a 'G' letter if the time is currently being synchronized with the GPS module)

below the data display, some icons may appear to signal the status of the controller.



Signal that a virtual keypad is connected.



















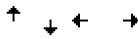

Signals that an Ethernet connection is established.



Signals that an Ethernet connection is being used for controlling the mount.



Signals that the GPS port is configured to use a GPS module.

	Signals that the GPS port is receiving data from a GPS module. If blinking, no valid position and time data has been received yet.
	The same as above, but GPS data are not used by the mount (Check Use GPS data function).
RS 232	Signals that a RS-232 connection is being used for controlling the mount.
	Signals that the mount is connected to a wireless network as a client.
	Signals that the mount is controlled over the wireless connection.
	Signals that the mount is configured as a wireless hotspot.
	Signals that the mount is configured as a wireless hotspot and another device is being used for controlling the mount.
	Signal that the mount is being moved by the keypad, an external command or the autoguider port. In the latter case, a small letter "A" also appears.
D	Dithering is active.
	Dithering is active and a dithering move has been done.
+	The mount is tracking at sidereal speed.
	The mount is tracking at solar speed.
	The mount is tracking at lunar speed.
STOP	The tracking has been deactivated.
	The mount is tracking at a speed selected by the user or by the Follow object function.
	The mount is slewing.
	The mount is in satellite tracking mode.
	The mount has been stopped by pressing the STOP key or has reached the tracking limits.
	The mount is parked and can't be moved; if the icon is blinking, the mount is slewing to the parking position.
	Signals that the dual tracking is active.
	Signals that the dual tracking is inactive.
	Signals that the UTC / Earth rotation data should be updated.
	Blinks when the battery keeping the time has failed. The icon is reset after a reboot of the mount.

Pressing the **MENU** key, you will enter the menu system and the display will show

```
>Objects
  Alignment
  Drive
  Local Data
  Settings
```

You can scroll the menu using the keys marked with the up/down arrows and **+ / -**. Five main submenus are available; they are **Objects**, **Alignment**, **Drive**, **Local Data** and **Settings**. You can

enter into a submenu by pressing **ENTER**. To exit from a submenu and return to the previous menu press **ESC**. Pressing **MENU** will make you return to the main data display, as well as pressing **ESC** when the main menu is displayed. For a complete reference of the menu system read the following chapters.

5.3.2 The Direction Keys

Use direction keys, labelled **N**, **E**, **S**, **W**, to move manually the telescope. Press one of these keys to accelerate the mount up to the selected speed, release it to decelerate until it stops. The **N** key makes the mount accelerate towards higher declinations, the **S** key towards lower declinations, the **E** and **W** keys towards east and west along the r.a. coordinates. In addition, you can press two keys simultaneously for diagonal movement.

The direction an object will move in the eyepiece depends also on the optical configuration of the telescope; the action of the keys can be exchanged in both axes to obtain a more comfortable control (see paragraph 6.3.3 and 6.3.4).

The speed can be selected with the keys **+ / -** (when outside of the menu system), and the selected speed is shown in the display for some seconds. The following speeds are available:

Angular speed	Rate to sidereal speed	Notes
2.25"/sec.	0.15x	
3.75"/sec.	0.25x	
7.5"/sec.	0.5x	
15"/sec.	1x	sidereal speed
1'/sec.	4x	
4'/sec.	16x	
15'/sec.	60x	
1°/sec.	240x	
4°/sec.	960x	only if slew rate > 4°/sec.
10°/sec.	2400x	only if slew rate > 10°/sec.
from 2°/sec. to 20°/sec.	from 480x to 4800x	slew rate, adjustable

The default speed at startup is the maximum speed (slew rate). By default the slew rate is limited to 8°/sec. In order to move at greater speeds, you need to change the slew rate setting (see paragraph 6.3.7). Every time you select a speed greater than 10°/sec., the keypad will emit a warning sound. Moving a telescope at high speed can be dangerous and you need the maximum caution.



CAUTION

Using a slew speed greater than 10°/sec. can be dangerous. Don't stay next to the mount or telescope. Keeping your eye near the eyepiece of any instrument during a move at high speed can seriously harm you.

The **E** and **W** keys can also be used to move the cursor when entering data.

5.3.3 The Numeric Keys

Beside being used to input numeric data, the numeric keys have a secondary function that is shown in small characters under the number. See the following table:

Key	Function
0 LIGHT	Switch the keypad backlight on and off.
1 COORD	Select R.A./Dec. coordinates of the object to slew to.
2 INFO	Show additional data of the current object.
3 DISP	Cycle the display between: R.A./Dec. coordinates; Az./Alt. coordinates; object data; countdown timer; chronometer; UTC clock; sidereal time and JD; local time clock.
4 STAR	Go to star selection menu.
5 PLANET	Go to planet selection menu.
6 MORE	Go to a menu with other selections: quick position settings, asteroids, comets, user defined objects, altazimuth coordinates, meridian flip, satellites.
7 M	Select a Messier object.
8 NGC	Select a NGC object.
9 IC	Select a IC object.

5.3.4 The MORE Key

If you press the **MORE** key, the mount will show a menu which contains object classes not covered by other numeric keys such as asteroids and comets. The first two items of the menu, however, can't be found under the standard Objects menu. They are dedicated to the "quick position" settings, which is a mean of quickly storing the position where the telescope is aimed to and recalling it later. This can be useful, for example, when you have to move away from your subject for some settings such as focusing and then go back to the previous position. To define a quick position, press **MORE**, select **Set Quick Pos**, press **ENTER**, and press a number corresponding to the position you want to save. You may save up to ten different positions. Later you can slew the scope to one of the defined positions: press **MORE**, press **ENTER**, and press the number corresponding to the position you want to slew to. Note that the positions are saved from one session to another.

5.3.5 The STOP Key

When you press the **STOP** key, the mount will halt its current movement. It will remain idle until a new movement command is issued (if it is not parked; see paragraph 5.7).

5.4 First Startup

This startup sequence will help you through the steps required to begin observing with the mount. You will learn to set your location and time, and perform the polar alignment. An internal clock will maintain the time, while the alignment should be repeated only when the mount is moved, or when the optical tube has lost the orthogonality with the declination axis. If none of these events has happened, you can switch off the system and at the next startup it will be ready for observation. The mount's absolute encoders will

keep track of the current position also if power is lost while operating the mount; no parking or homing is required.



CAUTION

When performing firmware upgrades, it is not guaranteed that the position of the mount will be retained in memory. Check the documentation provided with the upgrade for details.

5.4.1 Clearing a previous alignment

The first time you use the mount, it will not contain any alignment data. If the mount has been used before and you are going to setup it again in a different place or with a different instruments, you can clear the alignment memory. Press the **MENU** key and scroll down to the Alignment menu. Press **ENTER**. Select the **Clear align** function and press **ENTER**. The display will show

```
Confirm
Clear align?
```

Press **ENTER** again, then press **MENU** to exit from the menu.

5.4.2 Setting the Local Data

To find objects, the mount must know the current location, date and time. You can enter the data manually or use the optional GPS module to collect them.

If you are using the GPS module:

1. make sure that the GPS module is connected and that the GPS port is set to GPS (select **MENU - Settings - GPS port - GPS**);
2. select **MENU - Local Data - Use GPS data**;
3. The display will show the status of the GPS data acquisition process. When the acquisition has been completed, the display will show

```
GPS data
acquired
```

The procedure may require a few minutes. If the GPS is unable to complete the procedure, probably the GPS module is in a position where it has a poor visibility of the sky. In this case, change the position of the GPS module.

4. Now select **MENU - Local Data - Clock - Timezone**, enter the difference between your local time and UTC (positive east), in hours and minutes, and press **ENTER**. If you want to use UTC as your local time, enter 0.
5. Now go to DST (also in the **Local Data - Clock** menu); press **ENTER** to toggle the Daylight Saving Time ON and OFF. If you want to use UTC as your local time, select OFF.

Now you can go to paragraph 5.5.

If you want to choose a city from the database: You can choose a city from the location database as follows:

1. select **MENU - Local Data - Site - Select**;

2. choose your country with the **+** and **-** keys and press **ENTER** ;
3. choose a city near you (if available) and press **ENTER** .

If you want to enter location data manually:

1. select **MENU - Local Data - Site - Enter** ;
2. insert your longitude and latitude, in degrees, minutes, and seconds. You can use the **E - W** direction keys to move between the different input fields; when you have finished press **ENTER** ;
3. insert your elevation above sea level in meters and your time zone (difference between your local time and UTC, positive east, in hours and minutes) and press **ENTER** .
4. The mount will retain the coordinates indefinitely. You can review the current settings selecting **MENU - Local Data - Site - Current** . At this point you can also save the coordinates in the database; go to **MENU - Local Data - Site - Save** and insert a name using the **N - E - S - W** keys. The newly defined location will be accessed in **MENU - Local Data - Site - Select - User defined** .

Note that extreme accuracy of the observer's coordinates is not required, since they are used only to perform the correction for the refraction and to check the motion limits. A few arcminutes of accuracy is enough, so you can use a map to discover your latitude and longitude without any problem. As for elevation, it should be accurate to about 100 metres to compute refraction accurately.

Now you have to enter the local time. Go to **MENU - Local Data - Clock - DST** ; press **ENTER** to toggle the Daylight Saving Time **ON** and **OFF** until the settings corresponds to your current clock. Then go to **MENU - Local Data - Clock - Date and Time** and enter your time and date as you can read it from an accurate clock. You can use the **E - W** direction keys to move between the different input fields, and the arrow keys to choose the month. When you have finished, press **ENTER** .



NOTICE

Like all quartz clocks, the internal clock of the mount can drift slowly with time, especially if the mount is exposed to unusually low or high temperatures. Each second of error in the clock will worsen the pointing accuracy by 15 arcseconds. The clock should be kept accurately adjusted to maintain the pointing accuracy. This can be done manually, with the PC connection or with the GPS module. When adjusting the clock, it is not required to make a new alignment.

5.4.3 Setting the Refraction Parameters

The mount needs to know the temperature and pressure to compute the atmospheric refraction. By default, the mount uses a temperature of +10°C and an atmospheric pressure depending on your elevation assuming a pressure of 1013 hPa at sea level. If you need additional accuracy, go to **MENU - Local Data - Refraction - Set Temperature** and enter the air temperature in °C. You have three ways to enter the pressure. You can go to **MENU - Local Data - Refraction - Set Pressure** and enter the pressure in hPa. Or you can go to **MENU - Local Data - Refraction - Set Pressure 0** and enter the pressure in hPa at sea level; the pressure at your elevation will be calculated automatically. You can also go to **MENU - Local Data - Refraction - Auto Press** . and toggle **ON** the setting; in this case the pressure will be recalculated each time the elevation is changed. By default the refraction correction is enabled. It can be disabled if needed by toggling **MENU - Local Data - Refraction - Enable refr** . .

**NOTICE**

It is not advised to change any of the local data settings while tracking an object.

5.5 Alignment

Now the mount needs to be aligned to some reference stars and the polar axis aimed accurately at the celestial pole.

If properly aligned, the internal mount model will keep account of the polar misalignment and of the orthogonality error when pointing objects or tracking (provided that the dual tracking function described in paragraph 6.3.2 is active), but a significant polar error can lead to a visible field rotation. While this can be acceptable for visual observing, if you plan to use the mount for astrophotography or other scientific data collection, the polar axis should be properly aligned.

When making an alignment with 4 or more stars, the mount will fit a model of the flexure of the telescope tube. Using many stars (more than 10) it is possible to reach a pointing accuracy of 20 arcseconds RMS, provided that the telescope flexure can be modelled appropriately. An estimate of the expected pointing accuracy is given on the keypad after each additional calibration star is inserted.

It is better to do the alignment procedures using a high magnification reticle eyepiece, or the same imaging instrumentation you will use later; do not use a diagonal to centre the stars, unless it has been properly calibrated in order to avoid the orthogonality error.

**NOTICE**

Generally, the best way to obtain a good polar alignment is to make a three-stars alignment, or a two-stars alignment followed by a refinement; then to use the **Polar Align** function to align the r.a. axis; then repeat the three-stars alignment (or two-stars alignment followed by the refinement). You can check the estimated polar alignment error by using the **Align Info** function: usually after an alignment obtained in this way the error will be no worse than about 1'. Adding further alignment stars with the **Refine 2-stars** function improves the accuracy.

Do not use the **Polar Iterate** command as your default choice for aligning the polar axis if you do not have a compelling reason to do so, since you will obtain worse results in a longer time almost in any situation.

The following paragraphs details the steps that will be used in the different alignment procedures. For the different ways of setting up the mount for observation, see paragraph 5.5.8.

5.5.1 Two-stars Alignment

The two-stars alignment procedure measures the polar axis misalignment in order to achieve a good pointing accuracy even if the mount is misaligned. Proceed as follows:

1. Select **MENU - Alignment - 2-stars**. Choose one star among the ones provided and press **ENTER**, then choose another star and press **ENTER**. If the choice is too limited, i.e. you

cannot find a suitable pair of stars visible from your site, return to the first star selection by pressing **ESC** or use the three-stars alignment procedure.

2. Press **ENTER** to confirm the slew to the first star. After the slew, centre the star with the maximum precision using the keypad and press **ENTER**.
3. Press **ENTER** to confirm the slew to the second star. After the slew, centre the star with the maximum precision using the keypad and press **ENTER**.
4. Now the message **Alignment complete** will appear. The mount is now aligned.

Note that this procedure does not correct the orthogonality error of the telescope. If you are not sure that your telescope's optical axis is perfectly orthogonal to the declination axis, do a three-stars alignment or a refinement.

5.5.2 Three-stars Alignment

The three-stars alignment procedure measures the orthogonality error of the telescope's optical axis in addition to the polar axis misalignment, and uses it to improve the pointing accuracy. Furthermore, you can choose among more stars than using two-stars alignment, since the selection is less critical. On the other hand, you can choose stars in the same zone of sky, thus hampering the final accuracy.

1. Select **MENU - Alignment - 3-stars**.
2. Choose one star from the list and press **ENTER**.
3. Press **ENTER** to confirm the slew to the star. After the slew, centre the star with the maximum precision using the keypad and press **ENTER**.
4. Repeat the steps 2. and 3. for two other stars.
5. Now the message **Alignment complete** will appear. The mount is now aligned.

Even after the three-stars alignment, you can improve the mount model by adding more stars.

5.5.3 Alignment refinement

This procedure adds more star to an existing mount model, after a two-stars or three-stars alignment.

1. Select **MENU - Alignment - Refine Stars**.
2. Select a star among the list.
3. Press **ENTER** to confirm the slew to the star. After the slew, centre the star with the maximum precision using the keypad and press **ENTER**.
4. The message **Calculating...** appears, then the message **Align refined** followed by an estimation of the RMS pointing accuracy in arcseconds.

You can repeat this procedure up to 100 total alignment stars.

Note that if you do a two-stars alignment followed by a refinement, the result will be the same as if you had done a three-stars alignment. Keep also in mind that one of the major inaccuracies is usually the orthogonality error; in order to correct for this error, a three-stars alignment (or a two-stars alignment followed by at least one refinement) is required.

5.5.4 Aligning the Polar Axis with the Polar Align function

This procedure uses the data computed in the alignment step to align the polar axis. If done after at least a three-stars alignment, or a two-stars alignment followed by at least one refinement, it is insensitive to orthogonality error; moreover it can be done without using Polaris, so it is very useful if you can't see Polaris from your point of view.

The first thing to do is a two-stars alignment (paragraph 5.5.1) or a three-stars alignment (paragraph 5.5.2). After the alignment, the mount will know the polar axis misalignment. Now do the following:

1. Select **MENU - Alignment - Polar align** and select a star from the list.
2. The system will ask to slew to the star. Press **ENTER** to confirm.
3. The scope will slew to the star and miss it. Now move the polar axis of the mount with the altitude and azimuth movements as explained in paragraph 4.14 until the star is accurately centred in the field of view and press **ENTER**.

The polar axis now is correctly aligned, and the mount will point correctly.

However, it is advisable to make a new three-stars alignment in order to improve the pointing accuracy. At this point you can't use directly the **Refine Stars** function, since you would obtain a wrong model.

In order to obtain optimal performance, it is not required to correct physically the orthogonality error; if you wish to do so, however, the mount will help you with the procedure described in paragraph 5.5.6.

5.5.5 Iterative Alignment of the Polar Axis

This procedure uses a star (chosen among a small list) and Polaris to align the polar axis.

The accuracy of the alignment will depend of the orthogonality error of the optical axis: the larger the orthogonality error, the worse the polar axis will be aligned.

1. If you have not done it before, select **MENU - Alignment - Clear Align** and press **ENTER**.
2. Select **MENU - Alignment - Polar Iterate**.
3. The system will provide a small list of suitable stars. Choose the star you prefer and press **ENTER**.
4. Now the system will ask to slew to the star. Press **ENTER** to confirm the slew.
5. Centre the star with the keypad and press **ENTER**.
6. Now the system will ask to slew to Polaris. Press **ENTER** to confirm the slew.
7. Centre Polaris moving the polar axis with the altitude and azimuth movements as described in paragraph 4.14 and press **ENTER**.
8. Repeat the procedure from step 4 until both stars are centred with a good precision, i.e. you can slew between the two without significant errors.
9. Press **ESC** to terminate the procedure.

5.5.6 Correcting the Orthogonality Error

This procedure uses the data computed in the alignment step to correct physically the orthogonality error. It must be done after at least a three-stars alignment, or a two-stars alignment followed by at least one refinement. It is not necessary to correct physically the orthogonality error in order to obtain a good pointing accuracy or tracking.

1. Select **MENU - Alignment - Ortho align** and select a star from the list.
2. The system will ask to slew to the star. Press **ENTER** to confirm.
3. The scope will slew to the star and miss it. Now adjust the orthogonality of the telescope, for example by inserting shims, until the star is centred in the field of view and press **ENTER**.

The telescope is now orthogonal to the declination axis. It is advisable to make a new three-stars alignment in order to improve the pointing accuracy. At this point you can't use directly the Refine Stars function, since you would obtain a wrong model.

5.5.7 Visualisation of the Alignment Information

You can show the alignment information using **MENU - Alignment - Align info**. A short text will appear: scroll it with **+** and **-**. This text will tell you some useful information:

1. The type of alignment used: no complex alignment, 2-stars, 3 or more stars if you have used additional stars.
2. If 2 or more stars have been used, an estimation of the polar axis position error and its position angle relative to the celestial pole measured from the zenith towards the left, plus information about how to correct the error operating directly on the azimuth and altitude screws. An example of the display:

```

Alt 48°24'44"
Az 00°01'35"
Polar align error
00° 01' 20"
PA 232° 16'
To centre pol ax
move .04 Lf 0.2 Up

```

These values are examples of a very good alignment, requiring no further correction. The first two values show the position of the polar axis in altazimuth coordinates: **Alt** is the altitude above the horizon, ideally equal to your geographical latitude without sign; **Az** is the azimuth measured from north towards east, ideally equal to zero in the northern hemisphere and 180° in the southern hemisphere. The third angle, marked **Polar align error**, is the angular deviation of the polar axis from the celestial pole; the fourth angle, marked **PA**, is the position angle of the polar axis with respect from the celestial pole, where 0° is the line joining the celestial pole and the zenith, and the angle is measured counterclockwise; so 0° means that the polar axis is higher than the celestial pole, 90° that it is on the left, and so on. The required adjustment is shown as **.04 Lf 0.2 Up** meaning that the mount should be moved to the left by 0.04 revolutions of the azimuth adjustment screw and up by 0.2 revolutions of the altitude adjustment screw. Usually it is better to accomplish the adjustment with the polar alignment procedure described in paragraph 5.5.4.

3. If 3 or more stars have been used, an estimation of the orthogonality error is shown as

```

Scope ortho. err
+00°12'50"

```

meaning that the angle between the telescope optical axis and the declination axis deviates from 90° by 12'50". Also in this case, it is better to accomplish the adjustment with the orthogonality correction procedure (paragraph 5.5.6).

4. If four or more stars have been used, and the mount has been able to fit a flexure model to the alignment stars, the display will show the number of functions fitted and the expected RMS pointing accuracy (based on the alignment stars' data), as

```

Model terms: 11
Exp.RMS: 10.9"

```

5. The last item is a list of the stars used for alignment. This can be useful as a reference.

5.5.8 Alignment Procedures

By combining the procedures described above, you can align the mount in a number of different ways. Each way has its advantages and disadvantages.

Simple three-star alignment (not suitable for astrophotography use) This procedure allows the mount to point correctly without aligning the polar axis. Since the tracking is done in the r.a. axis only, the polar axis misalignment will cause rather large tracking errors and field rotation, making this procedure suitable only for casual visual observation.

Procedure:

1. Do a three-stars alignment (paragraph 5.5.2).

Otherwise:

1. Do a two-stars alignment (paragraph 5.5.1).
2. Add another star with the **Refine Stars** command (paragraph 5.5.3).

Polar alignment using the mount model This procedure will align correctly the polar axis even in presence of orthogonality error, and is the easiest and quickest way to align the polar axis. This ensures the best pointing accuracy, accurate tracking and no field rotation. Use this procedure for astrophotography or other scientific work.

Procedure:

1. Do a three-stars alignment alignment (paragraph 5.5.2)
2. Optionally, add one or more stars with the **Refine Stars** command (paragraph 5.5.3), to be repeated at will.
3. Execute the polar align command (paragraph 5.5.4)
4. Execute the ortho align command (paragraph 5.5.6)
5. Do again a three-stars alignment (paragraph 5.5.2)
6. Optionally, add one or more stars with the **Refine Stars** command (paragraph 5.5.3), to be repeated at will.

In the above procedure, the three-stars alignments can be replaced with two-stars alignments (paragraph 5.5.1) followed by at least one **Refine Stars** command (paragraph 5.5.3).

Polar iterate alignment With this procedure the polar axis is aligned to the celestial pole if there is no orthogonality error. An orthogonality error will worsen both the polar alignment and the pointing accuracy. This procedure requires only Polaris (or sigma Octantis in the southern hemisphere) and another star. Use this procedure only when you know that there is no orthogonality error, and if you cannot use the alignment procedure based on the mount model.

Procedure:

1. Align the polar axis with the **Polar Iterate** command (paragraph 5.5.5).
2. Do a three-stars alignment (paragraph 5.5.2).
3. Optionally, add one or more stars with the **Refine Stars** command (paragraph 5.5.3), to be repeated at will.

Otherwise:

1. Align the polar axis with the **Polar Iterate** command (paragraph 5.5.5).
2. Do a two-stars alignment (paragraph 5.5.1).
3. Add at least one or more stars with the **Refine Stars** command (paragraph 5.5.3), to be repeated at will.



NOTICE

In the above procedures you can always choose between doing a three-stars alignment and doing a two-stars alignment followed by a refinement with an additional star. In the first case you will have a greater choice of stars, so use the three-stars alignment when you have a limited field of view. In the second case the system will restrict the choice to stars placed in the best geometric conditions; this ensures a better accuracy.



NOTICE

If the polar axis is not aligned correctly, after an alignment the mount will point accurately, but tracking will be wrong, unless you activate the dual tracking option (paragraph 6.3.2). You will see the objects drifting in the field of view of the telescope, and also the equatorial coordinates on the keypad will change while tracking. This is not an error, but it is a symptom that the mount is misaligned.

5.6 Notes on autoguiding

When properly aligned, and using the dual axis tracking option, the GM2000HPS II mount is able to track stars with extreme accuracy. Usually autoguiding is not required, and may easily be counter-productive if the seeing is worse than about 1 arcsecond FWHM; in that case, guiding corrections will likely “correct” what are really movements of the guide star image due to the atmosphere.

With very long exposure times (tens of minutes) tracking errors could show nevertheless. In this case you will need autoguiding. In order to minimise the possible errors introduced by the guiding corrections, you will need to use a very low “aggressiveness” setting in your autoguiding software, and/or very low autoguide speed (down to 0.1x) and integration times up to several seconds.

If your alignment is not very good, you may use higher autoguider speeds and faster integration times in order to track objects, but accuracy will suffer accordingly.

Note that if you need to autoguide on the declination axis, you may obtain a slightly better result if you disable the dual axis tracking option, so that the declination corrections will be always in the same direction.

5.7 Parking the Mount

When the mount is parked, tracking is stopped and movement is not allowed. The control system, though, remains active. This allows you to “pause” the telescope during an observation session, without compromising its alignment and avoiding the need to restart the system.

The mount can be parked at the end of an observing session, to put the telescope in a predefined position i.e. to close a roof, or to have an easy access to instruments.

The parked/unparked status of the mount after power up depends on the setting of the function **MENU - Alignment - Boot Align** (see paragraph 6.2.14).

To park the mount, select **MENU - Alignment - Park** and press **ENTER** to confirm.

To unpark the mount, select **MENU - Alignment - Unpark** and press **ENTER** to confirm.

When the mount is parked, it will slew to a position called the “park position”. By default, the park position is the one shown in Fig. 5.11, with the telescope pointing at the celestial pole. The default park position can be unpractical, because the telescope can be too high to reach. You may define up to three custom parking positions. Select **MENU - Alignment - Park position - Set custom pos. 1/2/3**. Move the telescope in the desired position with the direction keys. In this phase, you may point the telescope beyond the security limits, so that you may define a parking position below the horizon or beyond the meridian limits. Pay the maximum attention in order to avoid collisions between the instruments and other objects such as the column, tripod or anything. Then press **ENTER**: the position will be saved in memory and the mount will remain parked.



Fig. 5.11: Default park position

**WARNING**

When you are choosing a custom park position, software limits on the horizon height and the meridian flip are deactivated. Pay the maximum attention not to cause collisions and damage to your instrumentation.

When you park the mount in a position below the horizon, the movement is made in two steps. In the first step, the mount will move the telescope to the horizon. If, in the parking position, the counterweight shaft will be below the telescope, the first step will bring the mount to the hour angle of the parking position, and the second step will be done moving only the declination axis. Otherwise, the mount will bring the counterweight shaft in a horizontal position, and the second step will be made moving both axes.

If you unpark the mount when the mount is parked below the horizon, the mount will move to the horizon, then it will be unparked.

To choose what to do when the mount is parked, select one of the following in **MENU - Alignment - Park position** :

- **Stops only** – when parked, the mount stops in the current position
- **Default park** – when parked, the mount slews to the position of Fig. 5.11.
- **Custom park 1/2/3** – when parked, the mount slews to the custom position 1/2/3.

The selected park position is marked with a star.

5.8 Switching off the Mount

The mount can be switched off in every moment, provided that no slew is underway (in this case, an abrupt stop can happen). It is not required that the mount is parked or put in a specific position.

To shut off the mount, operate on the power switch on the control box. The red power led will remain lighted for approximately 10 to 15 seconds; only when the led is off the power supply may be switched off.

You can shut off the mount using the function **MENU - Settings - Shutdown** .

6 The Menu System

The five main menus of the GM2000HPS II mount are **Objects** , **Alignment** , **Drive** , **Local Data** and **Settings** . The complete menu structure is detailed in chapter 13.

6.1 The Object Menu

The GM2000HPS II mount contains an extensive database of celestial objects. When an object is selected, the display shows some data: the name of the object, its type (for example, **Glob.** for globular cluster or **PlanNb** for planetary nebula) and magnitude (if available). Pressing the key **2-INFO** will show the equatorial coordinates of the object, and pressing it again will show the altazimuth coordinates.

The system will use the following abbreviations for the object type:

Abbreviation	Object type
Clust.	Open cluster
Cl+Neb	Open cluster with nebula
Glob.	Globular cluster
Quasar	Quasar
Galaxy	Galaxy
Unknow	Unknown type
Nebula	Diffuse or reflection nebula
Star	Star
DarkNb	Dark nebula
Planet	Planet
PlanNb	Planetary nebula
Satel.	Artificial satellite
Stars	Group of stars
Aster.	Asteroid
Astrsm	Asterism
Comet	Comet
Supern	Supernova remnant

The database coordinates are referred to epoch J2000.0 and are corrected for precession, nutation and light aberration; the atmospheric refraction is also considered.

If **ENTER** is pressed a second time (when the display shows object information), the telescope will slew to the object, provided that it is above the horizon limits as defined in paragraph 6.3.12. When the slew procedure completes correctly, the keypad will emit a beep sound.

To abort a slew for any reason, press **STOP** .

6.1.1 Deepsky

The mount provides the following catalogues:

Menu	Designation	Objects
Messier	Messier	Complete, 110 objects
NGC	New General Catalogue	Complete, 7840 objects
IC	Index Catalogue	Complete, 5386 objects
PGC	Principal Galaxy Catalogue	Complete up to 16m, 64570 galaxies
UGC	Uppsala General Catalogue of Galaxies	Complete, 12158 galaxies

To select an object from these catalogues, choose **MENU - Objects - Deepsky - [catalogue name]**, enter the catalogue number and press **ENTER**.

Some catalogues can be accessed using the shortcut keys from outside the menu: **7-M** for the Messier catalogue, **8-NGC** for the NGC catalogue, **9-IC** for the IC catalogue.

6.1.2 Star

The mount provides the catalogues in the following table (all are as complete as possible).

Menu	Designation	Remarks
Name	Proper name of the star	Use + / - and ENTER to choose from the list, in alphabetic order e.g.: Sirius
Bayer	Greek letter and constellation	Select the letter and the constellation using + / - , move between the two fields with the direction keys E - W . e.g.: alpha CMa (=Sirius)
Flamsteed	Number and constellation	Enter the number with the numeric keys, select the constellation using + / - ; move between the two fields with the direction keys E - W . e.g.: 9 CMa (=Sirius)
BSC	Bright Star Catalogue Harvard Revised	Enter the catalogue number e.g.: HR 2491 (=Sirius)
SAO	Smithsonian Astrophysical Observatory catalogue	Enter the catalogue number e.g.: SAO 151881 (=Sirius)
HIP	Hipparcos catalogue	Enter the catalogue number e.g.: HIP 32349 (=Sirius)
HD	Henry Draper catalogue	Enter the catalogue number e.g.: HD 48915 (=Sirius)
PPM	Position and Proper Motions catalogue	Enter the catalogue number e.g.: PPM 217626 (=Sirius)
ADS	Aitken's Double Star catalogue	Enter the catalogue number e.g.: ADS 5423 (=Sirius)
GCVS	General Catalogue of Variable Stars	See note

Note: the variable stars in the GCVS catalogue are identified by one or two letters and the name of the constellation, e.g. R Leo or UV Cet. The letters are assigned according to certain rules, which allow 334 identifiers in each constellation. When all these identifiers are assigned in a constellation, the star is identified with a letter V followed by a number starting from 335; thus V335 Ori is the 335th variable star found in Orion. When the GCVS catalogue is selected in the menu, you have to choose between **letter** and **number**. **letter** must be selected if the catalogue identifier is of the first kind (e.g.: R Leo); **number** must be selected if the catalogue identifier is of the second kind (e.g.: V335 Ori).

If you have chosen letter, select the letter(s) and the constellation using the **+ / -** keys, move between the two fields with the direction keys **E - W**.

If you have chosen number, enter the number with the numeric keys, select the constellation using **+ / -**; move between the two fields with the direction keys **E - W**.

The star menu can be accessed directly from outside the menu using the key **4-STAR**.

6.1.3 Planet

Choose the planet from the list using the **+ / -** keys and press **ENTER**, or press the corresponding numeric key: 0 – Sun, 1 – Mercury, 2 – Venus, 3 – Moon, 4 – Mars, 5 – Jupiter, 6 – Saturn, 7 – Uranus, 8 – Neptune, 9 – Pluto.

The planet menu can also be accessed from outside the menu using the key **5-PLANET**.

6.1.4 Moon feature

This submenu allows you to select specific features of the Moon such as craters.

- **Select feature** allows you to choose the specific feature you wish to observe. Available features are: Crater, Albedo feature, Catena, Dorsum, Lacus, Landing site, Mare, Mons, Promontorium, Rima, Rupes, Satellite feature, Sinus, Vallis. Features will be shown following the directives specified in the **Selection** submenu (see below).
- **Coordinates** allows you to specify selenographic coordinates to aim to (lunar longitude and latitude).
- **Terminator** aims at the center of the terminator.
- **Selection** is used to select which features should be shown. Here you may specify various requirements so that only features satisfying these requirements will be shown. The **Illumination** submenu controls which features must be shown based on the illumination status. **Whole Moon** shows all features, including those in the dark part of the Moon; this can be useful if you want to observe features lit by earthshine. **Illuminated** shows all features in the sunlit side, while **Terminator** shows only the features near the terminator. **Area Circle** allows you to choose a circle with a given radius (from 2' to 15') centered on the current location, so that only features lying in this circle will be shown; **Whole Moon** here means that features won't be selected based on this. You can control the sorting of the feature lists as follows. **Nearest first** will show first the features nearest to the current location of the mount, **Largest first** will show the features from the largest one, and **Sort by name** will allow you to easily search a given feature known by its name.
- **Sync on feature** is an additional function that allows you to obtain additional accuracy on the moon. To use this function proceed as follows. Select a small, recognizable feature on the Moon and slew to it. Then center the feature accurately. Now select **Sync on feature**. From now on, the position of all features you will select on the Moon will be corrected taking the feature you synchronized on as a reference. If the synchronization is not satisfactory, choose **Clear sync** to remove the correction. Note that this type of synchronization works only on the moon, and is completely unrelated to the alignment model.

6.1.5 Asteroid

After selection of the Asteroid menu you will have to wait a couple of seconds while the system calculates the list of asteroids. The list can be limited to objects brighter than a specified magnitude as described in paragraph 6.5.6.

The asteroid menu can be accessed from outside the menu using the key **6-MORE**.

You can choose the desired asteroid from the list; however it is advisable to use the official asteroid number from the Minor Planet Center (e.g. “2” for Pallas). This number can be entered directly into the keypad. You can find the official asteroid number using the web page at <http://ssd.jpl.nasa.gov/sbdb.cgi>.

See the documentation included with the updater program to learn how to update the asteroid table with the data you need.

6.1.6 Comet

The comet list contains several hundreds comets, beginning with **1P Halley**, **2P Encke** and so on. The list can be limited to objects brighter than a specified magnitude as described in paragraph 6.5.7.

The comet menu can be accessed from outside the menu using the key **6-MORE**.

You can choose the desired comet from the list; however it is also possible to enter the number directly into the keypad. You can find the complete designation of a comet using the web page at <http://ssd.jpl.nasa.gov/sbdb.cgi>.

The first entries have a number that can be entered directly into the hand pad; e.g. for “55P Tempel Tuttle” you will enter **55**. With the other comets you will have to enter the year of discovery, then scroll with the keys up to the comet of interest: e.g. for “C/2001 Q4 NEAT” you will have to enter **2001** and scroll with the **+ / -** keys.

See the documentation included with the updater program to learn how to update the comet table with the data you need.

6.1.7 Coordinates

Under this menu option you can enter the right ascension and declination coordinates of the target object. This is used for objects not in the database (like a new comet).

This function can be accessed from outside the menu using the key **1-COORD**.

To enter the coordinates use the numeric keys; you can move between the fields using the direction keys **E - W**.

6.1.8 User Defined

Here you can define your own database. This submenu has the following functions:

- **Add user obj.** - add a new object to the user database. You have to enter:
 - the equatorial coordinates of the object, using the numeric keys; you can move between the fields using the direction keys **E - W**. By default the display will show the coordinates to which the telescope is currently pointed to, so you can slew manually the telescope to the object to be inserted if you don't know its coordinates. Press **ENTER** to confirm.
 - The object type and magnitude. Use the **+ / -** keys to choose among the available types and enter the magnitude with the numeric keys; you can move between the fields using the direction keys **E - W**. Press **ENTER** to confirm.

- A name for the object, using the direction keys **N – S** to choose each letter and the direction keys **E – W** to move between the letters. Press **ENTER** to confirm.
- **Select user obj.** – slew the telescope to an object of the user database. The user database is shown in alphabetic order. Select the object to slew to by scrolling the list with the **+ / –** keys and press **ENTER**.
- **Delete user obj.** – delete an object from the user database. Select the object to be deleted by scrolling the list with the **+/-** keys and press **ENTER**. Press **ENTER** again to confirm the deletion.

This function can be accessed from outside the menu using the key **6-MORE**.

6.1.9 Alt/Az Coords

Use this function to slew to a point of known altitude and azimuth. This is particularly useful for ground-based objects, like e.g. points in the landscape etc.

This function can be accessed from outside the menu using the key **6-MORE**.

6.1.10 Meridian Flip

Usually the mount will point objects in the western part of the sky with the telescope to the east of the mount, and objects in the eastern part of the sky with the telescope to the west of the mount. It is not possible to follow an object through the meridian circle without turning around the telescope. In order to follow an object at the meridian, the GM2000HPS II mount has an user-selectable tolerance that allows the telescope to go beyond the meridian by a certain amount (paragraph 6.3.11). In this way, objects lying near to the meridian can be observed with the telescope either to the east or to the west of the mount. The “meridian flip” function forces the telescope to point at the same point of the sky from the other side. This function is available only when the telescope is aiming at a point near to the meridian; if you use it in another position, an error message will be shown.

6.1.11 Satellite

Use this menu to track an artificial satellite. The artificial satellite database must be loaded with the updater software. Since the orbits of artificial satellites can change in a few days, it is impossible to have a valid database pre-loaded in the mount.

Use the **Satellite Find** function to choose a generic satellite from the database. After pressing **ENTER**, the display will show a satellite name like

ISS (ZARYA)
(25544)

and all the others using the **+ / –** keys.

Use the **Next Passes** function to choose among the satellites visible in the next minutes. You need to insert the length of the time interval you want to consider in minutes from now, then a list containing only the visible satellites will be shown.

After choosing the satellite with **ENTER**, the display will show a list of the satellite’s passes in the next 24 hours, like this:

07:04:39–05:38

meaning that the satellite will be visible from 7:04:39 until 7:05:38.

Sometimes you will find a pass shown like this:

17:56:39–08:27

meaning that the satellite will be visible from 17:56:39 until 18:08:27.

Sometimes you will find two passes where the time intervals overlap, like this:

16:47:43–55:27
16:54:02–03:23

This happens when the mount cannot track the satellite in a whole run due to it going through the meridian. You can choose then if track the satellite in the arc before or after the meridian. The overlap depends on the **Flip Guide Tol.** setting (paragraph 6.3.11). If you choose the first of the two overlapping passes, after crossing the meridian the mount will slew automatically to catch the satellite in the remaining arc.

When you have chosen the pass you want, the mount will aim at the satellite. If the satellite is not visible yet, the mount will aim at the point where the satellite is expected to appear. Tracking of the satellite starts automatically.

While tracking the satellite, you can correct the position of the mount using the keypad. In this case the maximum speed you can use is limited to 15'/sec.

6.2 The Alignment Menu

The alignment menu provides functions to help in the mount setup, to park and unpark the mount. They have been described in the previous chapter so here we will refer to that section.

6.2.1 Park/Unpark

Park is shown is the mount is operating normally, while Unpark will be show if the mount is in parked status. Park will slew to the park position and park the mount, disallowing all movements, Unpark will exit from the parked status and allow the mount to move. See paragraph 5.7 for details about using this function.

6.2.2 Park Position

A submenu appears where you can choose what to do when parking.

- **Stops only** – when parked, the mount stops in the current position;
- **Default park** – when parked, the mount slews to the position of Fig. 5.11;
- **Custom park 1/2/3** – when parked, the mount slews to the custom position 1/2/3;
- **Set custom pos. 1/2/3** – saves the current position in memory as a custom park position.

Usage of this function is described in more detail in paragraph 5.7.

6.2.3 Polar Iterate

This function provides a method of aligning the polar axis using Polaris and a second star. See paragraph 5.5.5 for details about using this function.

6.2.4 2-Stars

This function allows you to align the mount using two stars as reference objects. See paragraph 5.5.1 for details about using this function.

6.2.5 Refine Stars

This function allows you to add more stars as reference points for calibrating the mount, it must be done after the **2-Stars** or **3-Stars** alignment functions. See paragraph 5.5.3 for details about using this function.

6.2.6 3-Stars

This function allows you to align the mount using three stars as reference objects. See paragraph 5.5.2 for details about using this function.

6.2.7 Delete star

This function will show the list of the alignment stars used, each with its residual error. If you find that a star has a big residual error, this means that the model doesn't fit the star appropriately, or that you pointed at the star not very accurately when making the alignment. If you press **ENTER**, you are given the choice to delete the star and recalculate the mount model automatically. Note that the first three align stars cannot be deleted.

6.2.8 Align Database

This function provides a sub-menu where you can save or recovery your alignment model data. This is useful if you have different instruments or configurations requiring different pointing models. It has three commands:

- **Load model** – load a previously saved alignment. The database is shown in alphabetic order. Select the alignment to load by scrolling the list with the **+ / -** keys and press **ENTER**.
- **Save model** – save the current alignment in the database. Enter a name for the current model using the direction keys **N - S** to choose each letter and the direction keys **E - W** to move between the letters. Press **ENTER** to confirm.
- **Delete model** – delete an alignment from the database. Select the alignment to be deleted by scrolling the list with the **+ / -** keys and press **ENTER**. Press **ENTER** again to confirm the deletion.

6.2.9 Clear align

Clear align deletes the current alignment. After that, the controller will assume an ideal mount, until more complex procedures, such as **2-stars** or **3-stars** alignment, are performed. See paragraph 5.4.1 for details about using this function.

6.2.10 Polar Align

This function allows you to align accurately the polar axis to the celestial pole using the alignment data and without using Polaris. It must be done after the 2-Stars or 3-Stars alignment functions. See paragraph 5.5.4 for details about using this function.

6.2.11 Ortho Align

This function allows you to correct the orthogonality error of the telescope using the alignment data. It must be done after the 2-Stars alignment function followed by a Refine Stars or after the 3-Stars alignment function. See paragraph 5.5.6 for details about using this function.

6.2.12 Align Info

This function shows various data about the current alignment, including the polar axis alignment error and the orthogonality error if a 2-Stars or 3-Stars alignment has been done. See paragraph 5.5.7 for details about using this function.

6.2.13 Sync Refines

This function allows the selection of the way of synchronizing the mount position with the sky, using the long press of the **ENTER** key or the synchronization commands on the RS-232/Ethernet links.

If this option is **OFF**, the mount will synchronize the position by adjusting the angle offset on both axes.

If this option is **ON**, the mount will use the synchronization as an additional reference star for the alignment model. If no alignment model has been computed, i.e. if you are in the situation following a **Clear Align** command, the first synchronization point will be used as the first star of a 3-Stars alignment, the second synchronization point will be used as the second star, and the third synchronization point will be used as the third star. In all other cases, the synchronization command is equivalent to a **Refine Stars** command. This mode is very useful if you have the mount connected to an external program using the LAN or serial link and you want to automate the building of a mount model. See the command protocol for details.

6.2.14 Boot Align

This submenu controls the alignment operations to be performed every time the mount is switched on.

- **Stay Parked** – When this option is selected, the mount will stay always parked after power on.
- **Last Status** – When this option is selected, the mount will be powered on in the same park status as it was switched off. This is the default option.
- **Alw. Unpark** – When this option is selected, the mount will begin normal operation even if it has been switched off in parked status. An exception is made when the mount has been switched off after being parked under the horizon. In this case, the mount will remain parked regardless of this setting.

6.3 The Drive Menu

The drive menu provides functions controlling the tracking and slewing of the mount.

6.3.1 Tracking Speed

The following options are available:

- **Sidereal** selects the sidereal speed, i.e. the speed used to track the “fixed” stars.
- **Solar** selects a speed corresponding to the average speed of the Sun. It is slightly different from the sidereal speed.
- **Lunar** selects a speed corresponding to the average speed of the Moon. It is rather differed from the sidereal speed, and should be used when observing the Moon. Note that this command does not keep account of the declination motion of the Moon, that can be noticeable; to have a more precise tracking, see the follow object function (paragraph 6.3.14).
- **Custom** allows you to specify a custom deviation from sidereal speed. It must be entered as arcseconds per minute of time of drift in right ascension and declination.
- **Stop** shuts down tracking, but allows moving the telescope. Useful to observe terrestrial objects.

6.3.2 Dual tracking

Press **ENTER** to activate or deactivate this function. When this function is active, the tracking will be done on both axes in order to compensate the drift due to alignment errors and atmospheric refraction. The best results can be obtained only if the system has been accurately aligned with multiple stars. We recommend that you activate this function as your default.

6.3.3 Swap *E* – *W*

When pressing the direction keys, the direction an object will move in the eyepiece depends on the optical configuration of the telescope. This function can swap the effect of the **E** and **W** keys on the keypad to obtain a more comfortable control. Press **ENTER** to activate (**ON**) or deactivate (**OFF**) this function.

6.3.4 Swap *N* – *S*

When pressing the direction keys, the direction an object will move in the eyepiece depends on the optical configuration of the telescope. This function can swap the effect of the **N** and **S** keys on the keypad to obtain a more comfortable control. Press enter to activate (**ON**) or deactivate (**OFF**) this function.

6.3.5 Auto Swap *N* – *S*

The action of the **N** and **S** keys is reversed with respect to the true North and South directions when the telescope changes from east to west of the meridian. This function can swap the effect of the **N** and **S** keys on the keypad depending on the side of the meridian you are looking at. Press enter to activate (**ON**) or deactivate (**OFF**) this function.

6.3.6 Corr. Speed

When moving the telescope in right ascension at high declination, the angular rate on the right ascension will be reduced by a factor $\cos \delta$, where δ is the declination. If this function is activated, the angular rate of the right ascension axis will be modified by multiplying it by $\cos \delta^{-1}$, thereby obtaining a constant angular rate on the sky. Press **ENTER** to activate (**ON**) or deactivate (**OFF**) this function. This function has effect also on the autoguide speed. By activating this function you can effectively avoid to realign your autoguide when if you observe at different declinations.

6.3.7 Slew Rate

Set the maximum speed in degrees/second, from 02°/s to 20°/s. If you choose a speed greater than 10°/s, the keypad will show a warning.

6.3.8 Autoguide speed

Here you can choose the autoguide correction speed among the values 1.00x, 0.50x, 0.33x, 0.25x, 0.20x, 0.15x and 0.10x the sidereal speed. This setting affects only corrections made using the autoguider interface (described in paragraph 5.1.2).

6.3.9 Tracking corr.

The tracking speed can be corrected up to $\pm 9.999\%$. A correction of 0.11% corresponds to a drift of 1 arcseconds per minute of time. During normal operation, this parameter should be set to 0.000% .

6.3.10 Flip Slew Tol.

Normally, the mount will point an object going to the “correct” side of the meridian; i.e. the telescope will be to the east of the mount when observing an object in the western sky and vice versa. This option allows you to “anticipate” an object that has not yet crossed the meridian, if the object is nearer than the specified value to the meridian. The user movements are blocked after they have gone through the meridian the “wrong way” more than this value. The value can vary from 0 to 30 degrees. Since this feature allows the telescope to go to the “wrong” side of the meridian, check that the value you enter here does not allow collisions between the instrumentation and the mount or the mount’s support.

6.3.11 Flip Guide Tol.

This option allows you to track an object through the meridian for up to 30 degrees on the “wrong” side. The value can vary from 2 to 30 degrees, and must be greater than the Flip Slew Tol. value. Since this feature allows the telescope to go to the “wrong” side of the meridian, check that the value you enter here does not allow collisions between the instrumentation and the mount or the mount’s support.

6.3.12 Horizon Limit

This is the minimum altitude angle the telescope will slew to. It is -1° by default and can be adjusted in the range -5° to $+45^\circ$.

Note that if the horizon limit is set to a value equal or greater than the absolute value of your geographical latitude, the mount won’t be able to point at the celestial pole, and the balance procedure will fail.

6.3.13 Track warn.

If this option is active, the mount will show a warning message and emit a sound whenever the tracking time left for an object crossing the meridian goes below 30, 10, 5, 2 and 1 minutes. The warning sound is composed of a long beep followed by two fast beeps that repeat every six seconds for a minute. In the last minute of tracking, and in the first minute after the tracking stops, you will hear a long beep every six seconds.

6.3.14 Follow Obj.

When this function is active, everytime you slew to a celestial object from the database, the apparent proper motion of the object is computed, and is set automatically as a “custom tracking rate” (paragraph 6.3.1). This is effective for all solar system objects, such as asteroids, comets, planets, the Sun and the Moon. Press **ENTER** to turn this option **ON** or **OFF**.

6.3.15 Balance

This submenu controls the balancing function. Here you find the following functions.

- **Balance RA** – This function is provided to help you in balancing the right ascension axis. Select the function and press **ENTER**. The telescope will slew in sequence to two balance positions, shown in Fig. 6.1 (A and B), starting from the nearest one, and will make an up and down movement at each position. At the end of the procedure the display will show the result of the measure as a percentage of the unbalancing. If the result is less than about 0.2%, the telescope is correctly balanced. If the display shows **Scope heavy**, move counterweights towards the end of the shaft or add counterweights. If the display shows **Shaft heavy**, move counterweights towards the end of the shaft or remove counterweights.
- **Balance Dec** – This function is provided to help you in balancing the declination axis. Select the function and press **ENTER**. The telescope will slew in sequence to two balance positions, shown in Fig. 6.1 (C and D), starting from the nearest one, and will make an up and down movement at each position. At the end of the procedure the display will show the result of the measure as a percentage of the unbalancing. If the result is less than about 0.2%, the telescope is correctly balanced. If the display shows "Front heavy", move the telescope backwards; if the display shows "Back heavy", move the telescope towards the front.

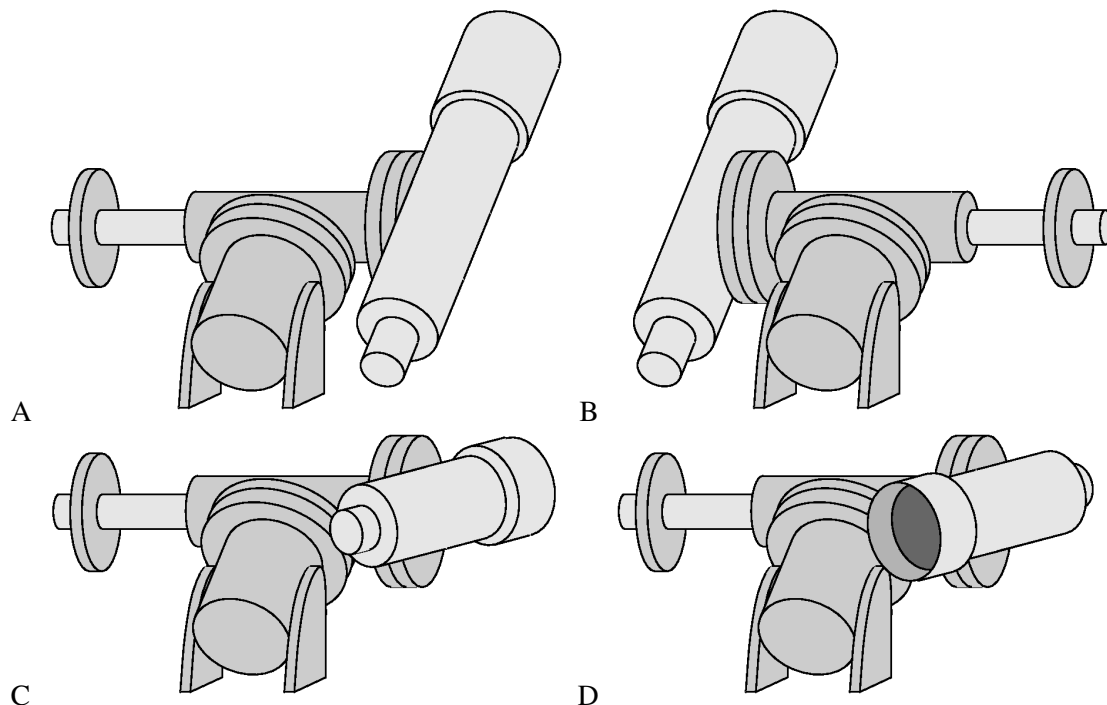

Fig. 6.1: Balance positions. A and B, positions for balancing the right ascension axis. C and D, positions for balancing the declination axis.

- **Conf balance** – This function toggles the confirmation checks in the balancing procedure. When **ON** (the default setting), confirmation checks will be provided before moving to each balancing position, and before each balancing oscillation.
- **Use slew speed** – When this option is set, the balance speed will be always equal to the slew speed.
- **Set bal. speed** – Use this function to set the balance speed separately from the slew speed.

6.3.16 Meridian side

This function controls the side of the meridian you can observe. As a security feature, you may restrict the motion of the mount to only one side of the meridian. Select **Both** if you want to allow the mount to slew

to both sides of the meridian (east and west). This is the normal operation, and is required for alignment and balance functions.

Select **West** or **East** if you want to restrict the mount so that the scope may point only at objects on one side of the meridian (west or east, respectively).

Select **Set this side** if you want to select the west or east side accordingly to the side where the scope is pointing.

When you try to slew to an object on the forbidden side of the meridian, the system will ask

**Force slew to
other side?**

By pressing **ENTER**, you will force the mount to point at the object. The allowed side of the meridian will be toggled so that you can go on pointing objects on the other side.

When pointing an object with the command protocol (i.e. from a planetarium software), the mount will fail the slew if the object is on the forbidden side of the meridian.

6.3.17 Preheating

When this function is **ON**, the mount will send current in the motors for about 120 seconds before starting up, so that motors and motor drivers are heated. This is used in very low temperatures to avoid the drivers to switch off the current due to temperature limits. Turn on this function only if your mount appears to power up normally but the motors don't move in very low temperatures. NEVER use this function when the ambient temperature is above 0°C.

6.3.18 Dithering

This menu controls the automatic dithering. It is possible to setup a random dithering in both axes, which is triggered based on timer settings that replicate those of an intervalometer. At the beginning of each interval, the mount moves randomly in both axes. The amount of movement follows a gaussian distribution whose standard deviation is controlled by the **Dither amount** settings.

Dithering is started and stopped with the specific display function (paragraph 7.3), or with the **Dither active** function of the menu. When the mount is moved or points at a new target, or its tracking is stopped, the dithering is deactivated.

In order to use the automatic dithering together with an intervalometer, copy the intervalometer settings to the mount, and start the sequence at the same time.

- **Dither amount** – Here you can set the amount of dithering in right ascension and declination, between 0 and 30 arcsecond.
- **Dither delay** – Controls the amount of delay, in seconds, between the press of the **ENTER** key and the start of the first exposure. It can be set from 0 to 99 hours.
- **Dither exposure** – Controls the length of each exposure in seconds, between 0 seconds and 99 hours.
- **Dither interval** – Controls the length of each exposure in seconds, between 5 seconds and 99 hours. The dithering movement is done in this interval.
- **Dither active** – Starts/stop the dithering.

6.4 Local Data

The local data menu is used to enter the data relative to your observing site (location, time, etc.).

6.4.1 Clock

Under this submenu you find the functions to set the clock of the mount.

- **Date and time** – Select this function to input the date and time. See paragraph for details about using this function.
- **Local Timezone** – Select this function to input the local time zone. See paragraph for details about using this function.
- **DST** (Daylight Saving Time) – Turn this option **ON** or **OFF** to activate or deactivate the daylight saving time correction. Select this function to input the date and time. See paragraph for details about using this function.

6.4.2 Site

This submenu has the following functions:

- **Current** – Show the current site information (name, coordinates, elevation and time zone). The text can be scrolled with the **+ / -** keys. Press **ESC** to leave the information display.
- **Select** – Select the observing site from a database of cities. See paragraph for details about using this function.
- **Enter** – Enter the coordinates of the observing site. See paragraph for details about using this function.
- **Save** – Save the current observing site to the user database. See paragraph for details about using this function.
- **Delete** – Delete an observing site from the user database. Select the site among the list and press **ENTER**, the press **ENTER** again to confirm deletion.

6.4.3 Use GPS Data

If the optional GPS module is connected to the control box, this function gets the exact coordinates of the observing site and the universal time (UTC). The time zone and the daylight saving time should be inserted manually if necessary (they are not necessary for locating objects correctly, but only to display the correct local time).

If the GPS module is already connected at boot and the corresponding boot option is active, the GPS data will be used as soon as possible after booting the mount. Otherwise, the GPS module can be connected later and the data can be collected with this function.

If this function is activated when the mount is already collecting data from the GPS module, the display will show

Using data from GPS

and GPS data will be used immediately. Otherwise, the display will show

Data will update with GPS fix

and GPS data will be used as soon as they are available.

This function cannot be activated if the GPS/RS-232 port is not set to **GPS** (see paragraph 6.5.2).

6.4.4 Boot GPS Sync

When this option is **ON**, a GPS module is searched at boot to get the date, time and geographical coordinates. Press **ENTER** to turn this option. This function cannot operate if the GPS/RS-232 port is not set to **GPS** (see paragraph 6.5.2).

6.4.5 GPS-UTC diff

Shows the current value of the difference between GPS and UTC time, in seconds. The firmware accounts automatically for the difference between GPS and UTC time based on data downloaded by the updater software.

6.4.6 Refraction

This submenu is used to input data for computing the refraction. It has the following functions:

- **Show Current** – Show the current refraction data. The text can be scrolled with the **+ / -** keys. Press **ESC** to leave the information display.
- **Set Temperature** – Enter the air temperature at the observing site.
- **Set Pressure** – Enter the atmospheric pressure at the observing site in hPa.
- **Set Pressure 0** – Enter the atmospheric pressure at sea level in hPa, if the pressure at the observing site is not available.
- **Auto Press.** – If this function is selected, the pressure will be computed automatically from the elevation data in **MENU - Local data - Site**.
- **Enable refr.** – If this function is selected, the refraction correction is enabled. During normal operation the refraction correction should be enabled.

The setting of the refraction data is explained in paragraph 5.4.3.

6.5 Settings

The settings menu is used to setup the mount and customise its operation. Some of the functions of this menu have already been described in previous sections, so here we will refer to that sections if necessary.

6.5.1 User Interface

In this submenu you can set various functions related to the user interface of the keypad.

- **Brightness** – The brightness of the display can be adjusted at the following levels: **Maximum - High - Medium - Low - Minimum**. The current level is marked with a star.
- **Contrast** – The contrast of the display can be adjusted at the following levels: **Maximum - High - Medium - Low - Minimum**. The current level is marked with a star. Usually **High** is the correct value, except when the ambient temperature is high.
- **Beep Volume** – This function controls the “beep” sound of the keypad. The volume can be adjusted at the following levels: **High volume - Low volume - Beep off**.
- **Boot Display** – This controls what the display should show by default after switching on. Choose among:

RA/Dec Coord.	Show the equatorial coordinates
Alt/Az Coord.	Show the altazimuth coordinates
Lcl time clock	Show the current local time
UTC clock	Show the UTC time
Chrono	Show the stop clock (paragraph 7.2)
Timer	Show the timer (paragraph 7.1)
Dithering control	Show the dithering controls (paragraph 7.3)

The date and time are always displayed at first after boot, this settings becomes effective after the pressure of e.g. the direction keys. The key **3-DISP** can be used to switch between the display of the various information above, and additionally the Sidereal Time and Julian Date.

- **J2000.0** - This option makes the keypad show equatorial coordinates in the standard equinox J2000.0. In this case, the letter **J** will appear after the declination in the display.

6.5.2 GPS Port

This menu selects the functionality of the GPS/RS-232 port.

Choose:

- **GPS** - to allow searching for a GPS module connected to the GPS/RS-232 port.
- **Serial** - to use the GPS/RS-232 port as a RS-232 port for remote control.
- **Dome** - to control a Baader Planetarium motorized dome connected directly to the GPS/RS-232 port.

6.5.3 Emulation

This menu concerns the emulation mode of the mount communication. This is used to increase compatibility with existing software. Choose:

- **Emul. LX200N** to emulate the native Meade LX200 protocol, increasing compatibility with software coded for Meade controllers
- **Emul. LX200X** to emulate the extended LX200 protocol, increasing compatibility with software coded for Astro-Physics controllers

The active emulation is marked with a star.

6.5.4 Network

The GM2000HPS II can be operated by remote control over an Ethernet LAN with the TCP/IP protocol. See chapter 9 for details.

- **Show IP address** - The current network parameters are shown. Scroll the text with the **+ / -** keys, press **ESC** to leave the information display.
- **Config Network** - The network configuration can be set to one of the following:
 - **Use DHCP** - When this option is selected, the mount will ask a DHCP server on the network to provide an IP address.

- **Set IP address** – When this option is selected, the parameters can be entered manually; this is useful if your network does not have a DHCP server or if you are connecting the mount directly to a PC with a “crossed” cable. The following parameters should be entered: **IP address** , e.g. **192.168.001.099** (different from the IP address of the PC but on the same subnet); **Network mask** , e.g. **255.255.255.000** ; **Gateway** , e.g. **192.168.001.001** . (the actual data may differ from these depending on the configuration of your network)
- **Rem. Assist** – Start the remote assistance system. This system allows the manufacturer to connect to the mount and diagnose some problems using an Internet connection. It is necessary to contact the manufacturer in advance to use this system. Furthermore, it is required that the mount is able to connect to the Internet. If your Internet access happens through a typical modem/router, usually it is enough to connect the mount to the router and use the DHCP server for the configuration (select **Use DHCP** in the menu **Config Network**).

6.5.5 Wireless

If the wireless option is installed, this submenu allows you to configure the settings of the wireless network interface.

- **WLAN Client** – Configure the wireless interface as a client. After selecting this entry, the mount will search for visible wireless LANs, and after a few seconds it will show a list. Select the network you want to connect to. Then enter the WEP or WPA key for accessing the network. After this, you have the option to get the IP address from a DHCP server on your network (**Get from DHCP**) or set it manually (**Set manual IP**). Usually you will select the DHCP server and press ENTER in order to obtain automatically the IP address. Otherwise, you will have to enter the IP address to use, the network mask and the default gateway. The display will return to the **WLAN Client** selection. After a few seconds, if the configuration was completed without errors, it will show **WLAN configured** followed by the IP address of the wireless interface.
- **WLAN Hotspot** – Configure the wireless interface as a WEP hotspot. After selecting this entry, you will have to enter the WLAN Name (you will connect other devices to this WLAN afterwards). Then select the encryption (WPA-PSK or WEP). *Note: the WPA encryption is strongly preferred. The WEP encryption is not secure and must be used only if you are required to connect with an exceedingly rare device that doesn't support the WPA encryption.* Then insert the WPA passphrase or the WEP key, the IP address of the mount and the network mask. The mount will provide a DHCP server giving addresses corresponding to these data. For example, if you configure the mount with an IP address of 192.168.2.1 and a network mask of 255.255.255.0, the mount DHCP server will provide IP addresses from 192.168.2.2 to 192.168.2.254 to other devices.
- **WLAN Off** – Shut down the wireless interface.
- **WLAN Purge** – Select this to delete all WLAN information recorded into the mount, such as security keys.
- **Country Code** – Here you may choose the country you are located to enable channels for the hotspot configuration.
- **Hotspot Channel** – Select the channel you want to communicate on when the wireless adapter is configured as an hotspot.
- **Show WLAN info** – Shows information about the current wireless configuration.

**WARNING**

Pay attention when you choose the communication channel. Depending on the country you are located, the use of some channels may be restricted. Choosing a channel that is allowed by your local regulations is under your responsibility.

6.5.6 Asteroid Filter

The list of asteroids can be limited to objects brighter than the specified magnitude. Press **ENTER** to enter the menu; the following functions are available:

- **Filter** – Control whether the filter is active or not. Press **ENTER** to turn this option **ON** or **OFF**.
- **Limit magnitude** – Pressing **ENTER** will show the current magnitude limit; enter a new magnitude limit with the numeric keys and press **ENTER**.

6.5.7 Comet Filter

The list of comets can be limited to objects brighter than the specified magnitude. Press **ENTER** to enter the menu; the following functions are available:

- **Filter** – Control whether the filter is active or not. Press **ENTER** to turn this option **ON** or **OFF**.
- **Limit magnitude** – Pressing **ENTER** will show the current magnitude limit; enter a new magnitude limit with the numeric keys and press **ENTER**.

6.5.8 Shutdown

This command shuts down the mount after confirmation from the user.

6.5.9 Dome

This menu contains the settings for controlling a Baader Planetarium motorized dome, connected to the mount using the GPS/RS-232 port with serial adapter. Press **ENTER** to enter the menu; the following functions are available:

- **Open Shutter** – opens the dome.
- **Close Shutter** – closes the dome.
- **Home** – forces the dome to do a 360 degrees rotation, to force the detection of the homing sensor.
- **Dome Control** – here you can choose between **No dome** or **Dome on GPS** to set the port where the dome is connected. The mount will send the azimuth to the dome at fixed intervals. Select **Update interval** to change the interval; the default is 5 seconds. Use **Dome radius** to specify the dome radius (not diameter) in mm.
- **Mount position** – specify the mount position with respect to the dome. **Xm**, **Ym** and **Zm** are the offsets of the mount towards North, East and the Zenith, respectively, measured in mm from the centre of the spherical part of the dome to the centre of the base of the mount (see Fig. 6.2).

- **Scope offset** – specify the position of the optical axis of the telescope relative to the declination mounting flange (see Fig. 6.3, Fig. 6.4). **X** is the lateral displacement, measured from the centre of the mounting flange, positive towards right if looking from the back of the optical tube (usually **X** is zero). **Y** is the distance from the flange to the optical axis (usually it is the radius of the optical tube). All measures are in mm.
- **Park close** – when activated, this option causes the dome shutter to be commanded to close everytime the mount is parked (with the keypad or with the command protocol).
- **Unpark open** – when activated, this option causes the dome shutter to be commanded to open everytime the mount is unparked (with the keypad or with the command protocol).



NOTICE

If the parameters for the dome control are not specified correctly, the dome will behave erratically or not move at all. Check that all the data are correct before suspecting communication problems.

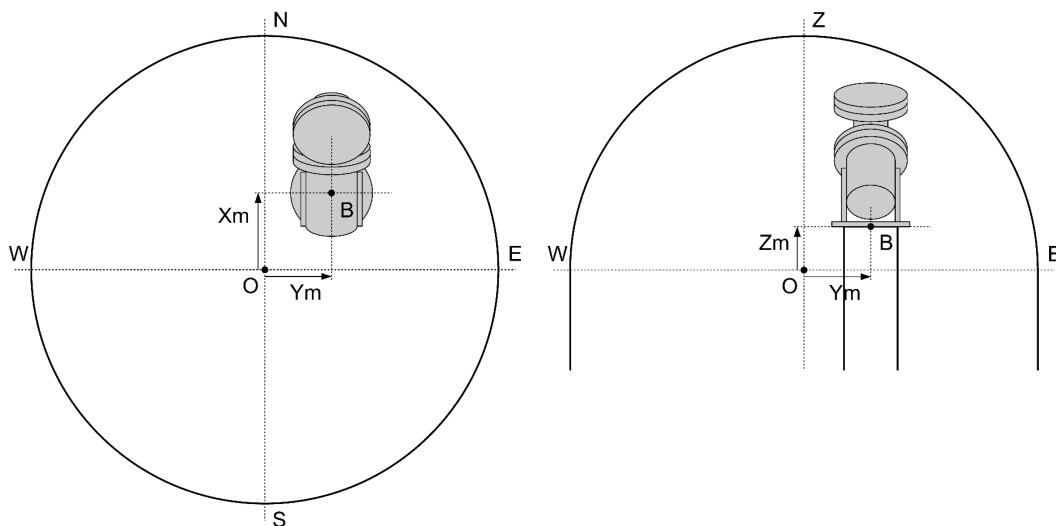

Fig. 6.2: Position of the mount inside the dome. Note that measurements are taken from the centre of the spherical part of the dome to the centre of the base of the mount. Usually **Zm** will be negative.

6.5.10 Version

This function shows a text containing the firmware revision and date, and the version of the r.a. and dec. motors' firmware. Scroll the text with the **+ / -** keys, press **ESC** to leave the information display.

6.5.11 Language

This function allows you to choose the language for the interface of the keypad. The languages supported depend on the version of the keypad attached to the mount.

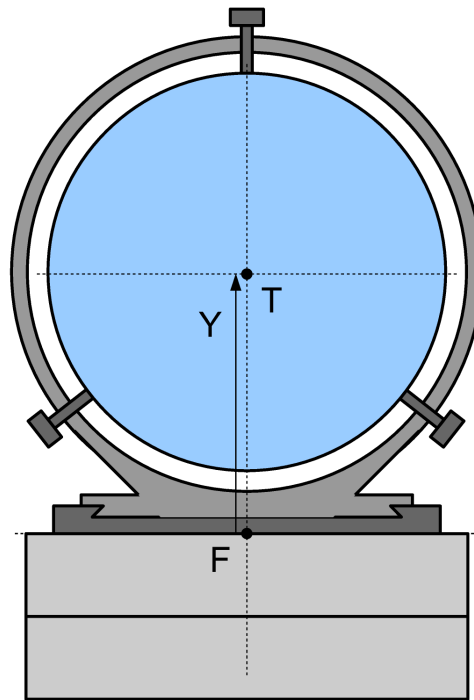

Fig. 6.3: Position of the optical tube assembly with respect to the declination flange, seen from the back of the optical tube. This is the usual case where the optical tube assembly is centered with respect to the declination axis; in this case \mathbf{x} is zero

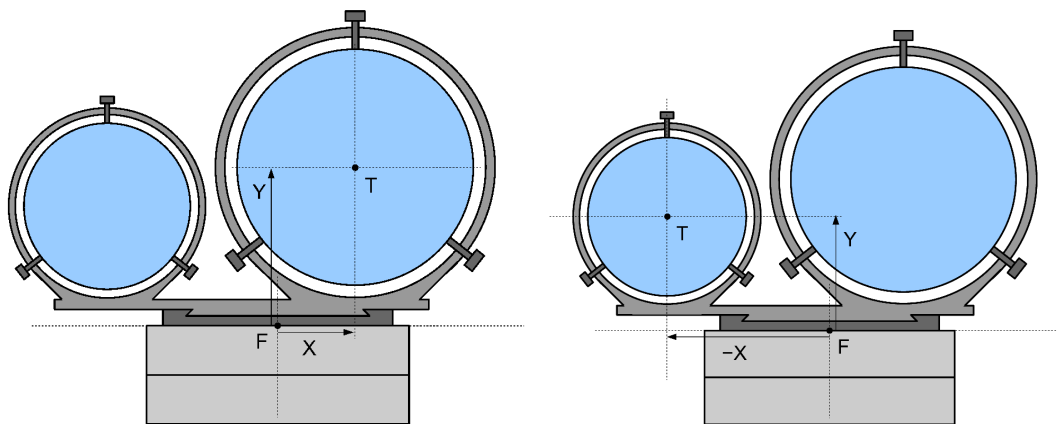

Fig. 6.4: Position of the optical tube assembly with respect to the declination flange, seen from the back of the optical tube. This is a configuration with two optical tubes. To centre the dome shutter above one of the two instruments, specify \mathbf{x} and \mathbf{y} as in the drawings. In the right image, \mathbf{x} is negative, since the optical axis is to the left of the declination axis.

6.5.12 Security

With this menu you may lock/unlock most of the functions of the mount so that it can be used by unexperienced people in the most safe way. When the lock is active, all keypad functions are made unavailable except:

- all objects pointing functions;

- the park - unpark function;
- the drive speed selection function;
- the follow object option;
- the dome opening, closing and homing functions;
- the unlock function (protected by a PIN).

In order to activate the lock, select the **Lock advanced** function from the menu. From now on, the keypad will show only the allowed functions. The lock can be deactivated with the **Unlock advanced** function. This function will require a PIN to work. By default, the pin is **12345** . It may be changed as will with the **Set PIN** function.

7 Additional Functions

These utility functions are provided outside the menu, and can be accessed by pressing the key **3-DISP**.

7.1 Countdown Timer

This timer function is useful e.g. for astrophotography. Press the key **3-DISP** several times, until **Countdown timer** is shown on the display. A two-line display will appear:

```
00:00:00.0 Left
00:00:00.0 Tot
```

The numbers stands for hours, minutes, seconds and tenths of second.

Press **ENTER** to set the desired time interval. The display will change to

```
Set timer
00:00:00.0 Tot
```

where you can change the time using the numeric keys and the **E - W** direction keys to move between the fields. Press **ENTER** to start the countdown. The timer begins to run and when the count reaches zero several beeps will warn you that the timer is expired.

Press **ENTER** while the timer is running to stop the countdown.

7.2 Stop Watch

This stopwatch function is useful for measuring time intervals. Press the key **3-DISP** several times, until **Chronometer** is shown on the display. A single-line display will appear:

```
00:00:00.0
```

The numbers stands for hours, minutes, seconds and tenths of second. Press **ENTER** to start measuring the time interval. The timer begins to run and will continue until you press **ENTER** again to stop it. To zero the timer, press **ENTER** a third time.

7.3 Dithering control

Here you can start/stop the dithering and check the dithering timer. If dithering is not active, this display shows **ENTER to start** if the mount is in a state where dithering can be started. In this case, pressing **ENTER** starts the dithering. If dithering is active, the display shows the time left in the current state, which cycles between **delay**, **expose** and **interval**. Pressing **ESC** in this state stops the dithering. Dithering is stopped also when the mount is moved with the keypad, by remote control or when slewing to an object.

8 Alignment Stars

This chapter provides a list of the stars used for the alignment of the mount. The mount knows the position of the alignment stars with extra accuracy, and corrects also their proper motions. Charts for locating the alignment stars in the sky are provided.

8.1 List of Reference Stars Sorted by Constellation

Constellation name		
Latin	English	Stars
Andromeda	Andromeda	Mirach – Alpheratz
Aquarius	Water Carrier	Beta Aqr – Lambda Aqr
Aquila	Eagle	Altair
Aries	Ram	Hamal
Auriga	Charioteer	Capella
Boote	Herdsmen	Arcturus
Camelopardalis	Giraffe	Alpha Cam
Canes Venatici	Hunting Dogs	Cor Caroli
Canis Major	Greater Dog	Sirius
Canis Minor	Lesser Dog	Procyon
Capricornus	Goat	Omega Cap
Cassiopeia	Cassiopeia	Caph – Gamma Cas
Centaurus	Centaur	Menkent
Cepheus	Cepheus	Alderamin
Cetus	Whale	Diphda – Menkar
Corona Borealis	Northern Crown	Gemma
Corvus	Crow	Gienah Ghurab
Cygnus	Swan	Albireo – Deneb
Draco	Dragon	Eltanin
Eridanus	River	Zaurak
Fornax	Furnace	Alpha Fornacis
Gemini	Twins	Castor – Pollux
Hercules	Hercules	Zeta Herculis – Pi Herculis
Hydra	Water Serpent	Alphard
Leo	Lion	Denebola – Regulus
Libra	Balance	Zuben el Genubi
Lynx	Lynx	Alpha Lyncis
Lyra	Lyre	Vega
Ophiucus	Serpent Bearer	Ras Alhague – Nu Ophiuchi
Orion	Orion	Betelgeuse – Rigel
Pegasus	Pegasus	Algenib – Enif – Scheat
Perseus	Perseus	Mirfak – Zeta Persei

Constellation name		
Latin	English	Stars
Puppis	Stern	Rho Puppis
Scorpius	Scorpion	Antares
Serpens	Serpent	Unukalhai
Taurus	Bull	Aldebaran
Ursa Major	Great Bear	Alkaid – Dubhe – Muscida – Alula Borealis
Ursa Minor	Little Bear	Kochab – Polaris
Virgo	Virgin	Spica – Vindemiatrix

8.2 List of Reference Stars Sorted by Name

Star	Constellation name	
	Latin	English
Albireo	Cygnus	Swan
Aldebaran	Taurus	Bull
Alderamin	Cepheus	Cepheus
Algenib	Pegasus	Pegasus
Alkaid	Ursa Major	Great Bear
Alpha Cam	Camelopardalis	Giraffe
Alpha Fornacis	Fornax	Furnace
Alpha Lyncis	Lynx	Lynx
Alphard	Hydra	Water Serpent
Alpheratz	Andromeda	Andromeda
Altair	Aquila	Eagle
Alula Borealis	Ursa Major	Great Bear
Antares	Scorpius	Scorpion
Arcturus	Boote	Herdsman
Beta Aqr	Aquarius	Water Carrier
Betelgeuse	Orion	Orion
Capella	Auriga	Charioteer
Caph	Cassiopeia	Cassiopeia
Castor	Gemini	Twins
Cor Caroli	Canes Venatici	Hunting Dogs
Deneb	Cygnus	Swan
Denebola	Leo	Lion
Diphda	Cetus	Whale
Dubhe	Ursa Major	Great Bear

Star	Constellation name	
	Latin	English
Eltanin	Draco	Dragon
Enif	Pegasus	Pegasus
Gamma Cas	Cassiopeia	Cassiopeia
Gemma	Corona Borealis	Northern Crown
Gienah Ghurab	Corvus	Crow
Hamal	Aries	Ram
Kochab	Ursa Minor	Little Bear
Lambda Aqr	Aquarius	Water Carrier
Menkar	Cetus	Whale
Menkent	Centaurus	Centaur
Mirach	Andromeda	Andromeda
Mirfak	Perseus	Perseus
Muscida	Ursa Major	Great Bear
Nu Ophiuchi	Ophiucus	Serpent Bearer
Omega Cap	Capricornus	Goat
Pi Herculis	Hercules	Hercules
Polaris	Ursa Minor	Little Bear
Pollux	Gemini	Twins
Procyon	Canis Minor	Lesser Dog
Ras Alhague	Ophiucus	Serpent Bearer
Regulus	Leo	Lion
Rho Puppis	Puppis	Stern
Rigel	Orion	Orion
Scheat	Pegasus	Pegasus
Sirius	Canis Major	Greater Dog
Spica	Virgo	Virgin
Unukalhai	Serpens	Serpent
Vega	Lyra	Lyre
Vindemiatrix	Virgo	Virgin
Zaurak	Eridanus	River
Zeta Herculis	Hercules	Hercules
Zeta Persei	Perseus	Perseus
Zuben el Genubi	Libra	Balance

8.3 Alignment Star Charts

Use the charts in the following pages to locate the appropriate alignment stars. There are four charts for the northern hemisphere and four charts for the southern hemisphere, each corresponding to a different period of the year. Find the chart corresponding to your hemisphere and to the period of the year, then orient it with the cardinal points.

The stars shown for each period of the year are the ones visible in first part of the night; if you are working in different hours, you will have to use another chart. Also, near the equator you may have to use stars both from the northern and the southern hemisphere charts.

8.3.1 Northern Hemisphere Chart – March to May

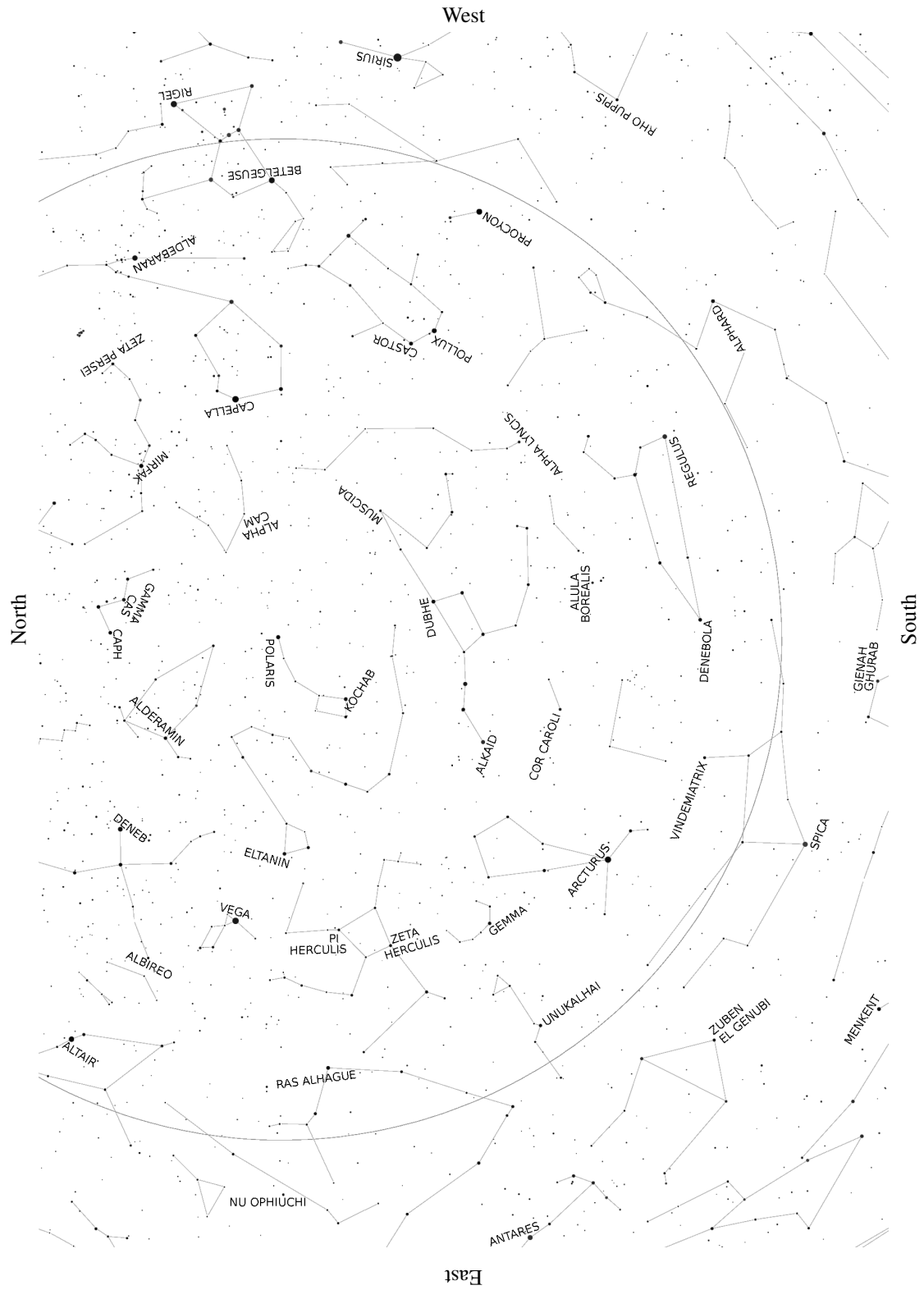

8.3.2 Northern Hemisphere Chart – June to August

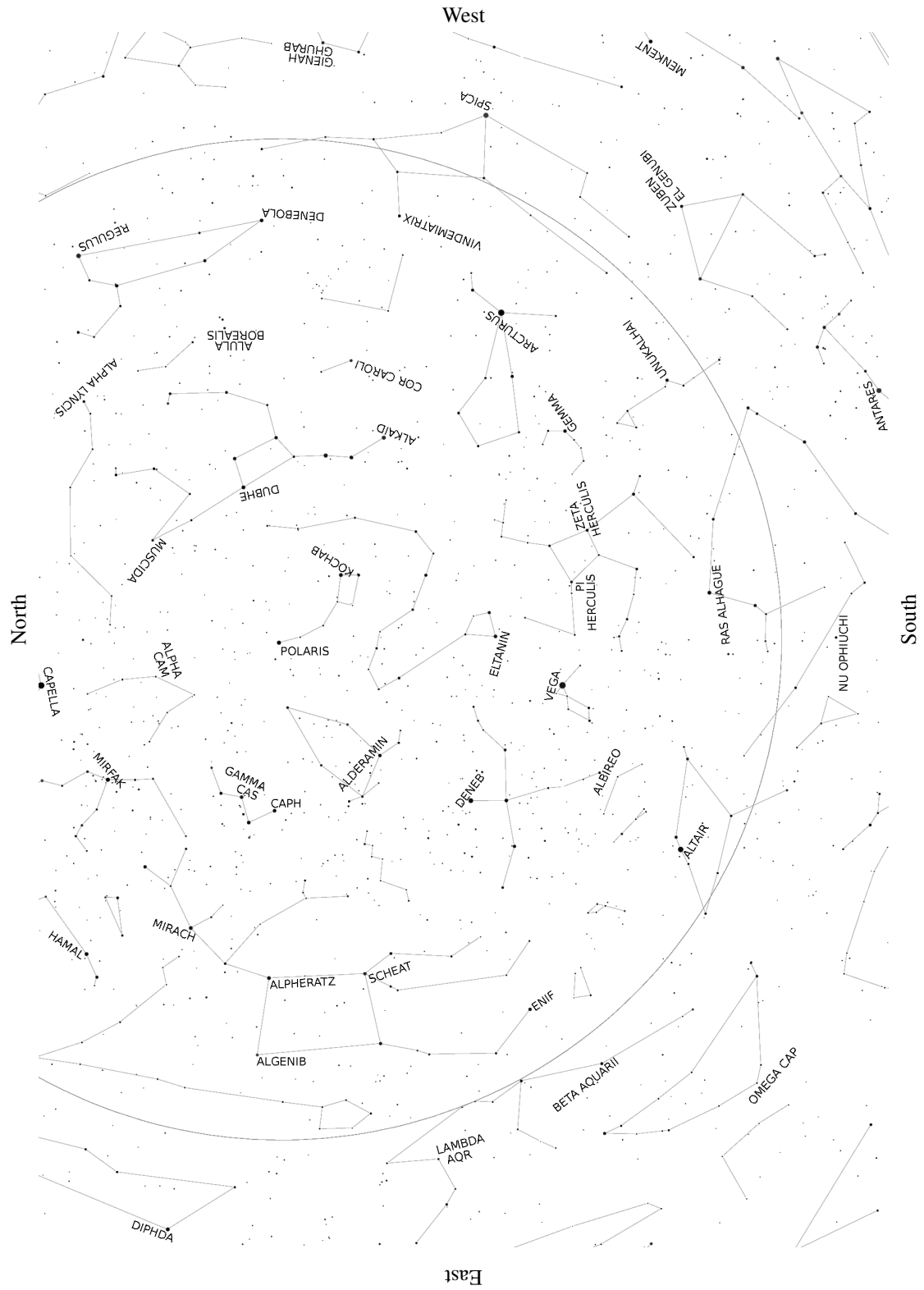

8.3.3 Northern Hemisphere Chart – September to November

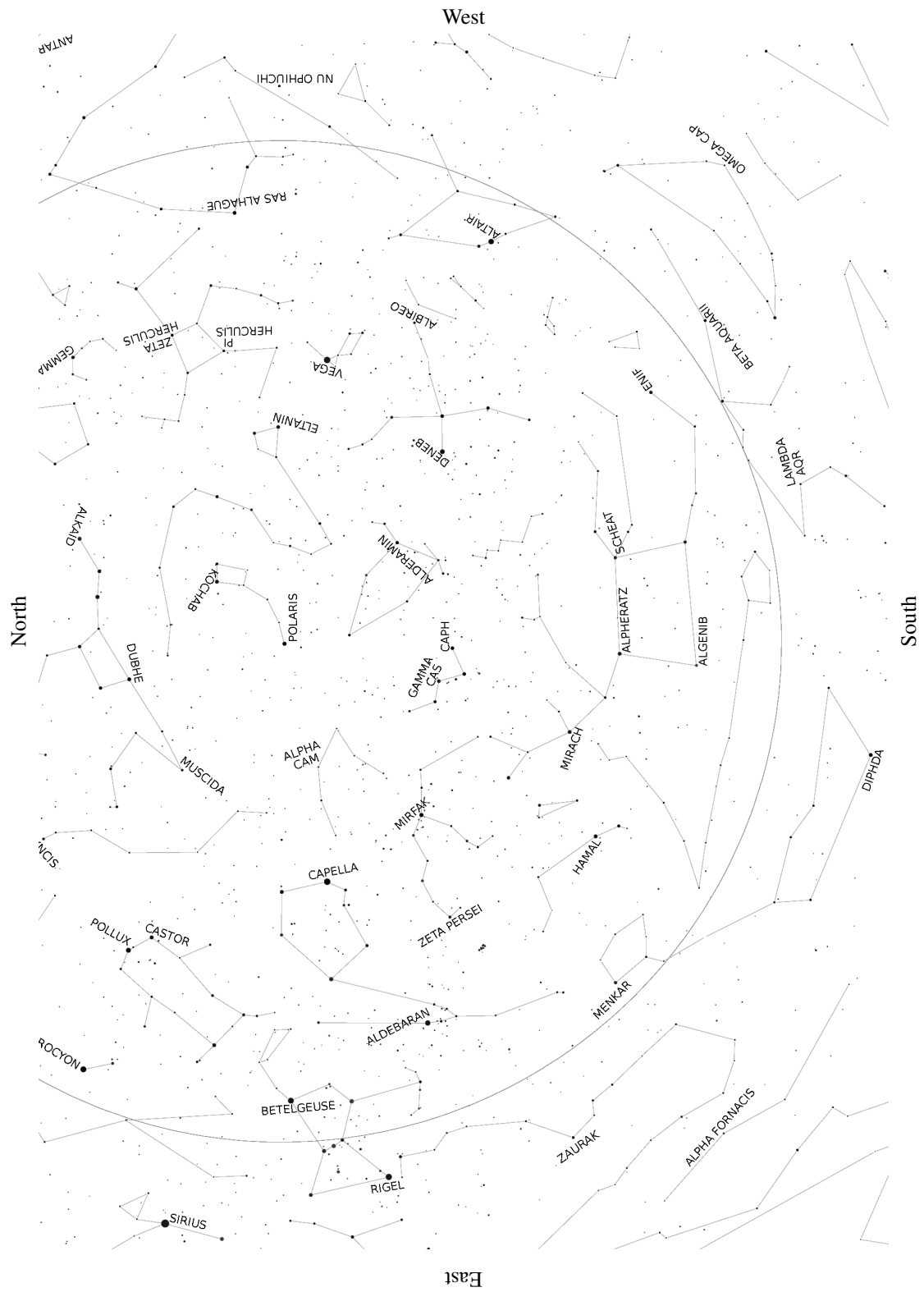

8.3.4 Northern Hemisphere Chart – December to February

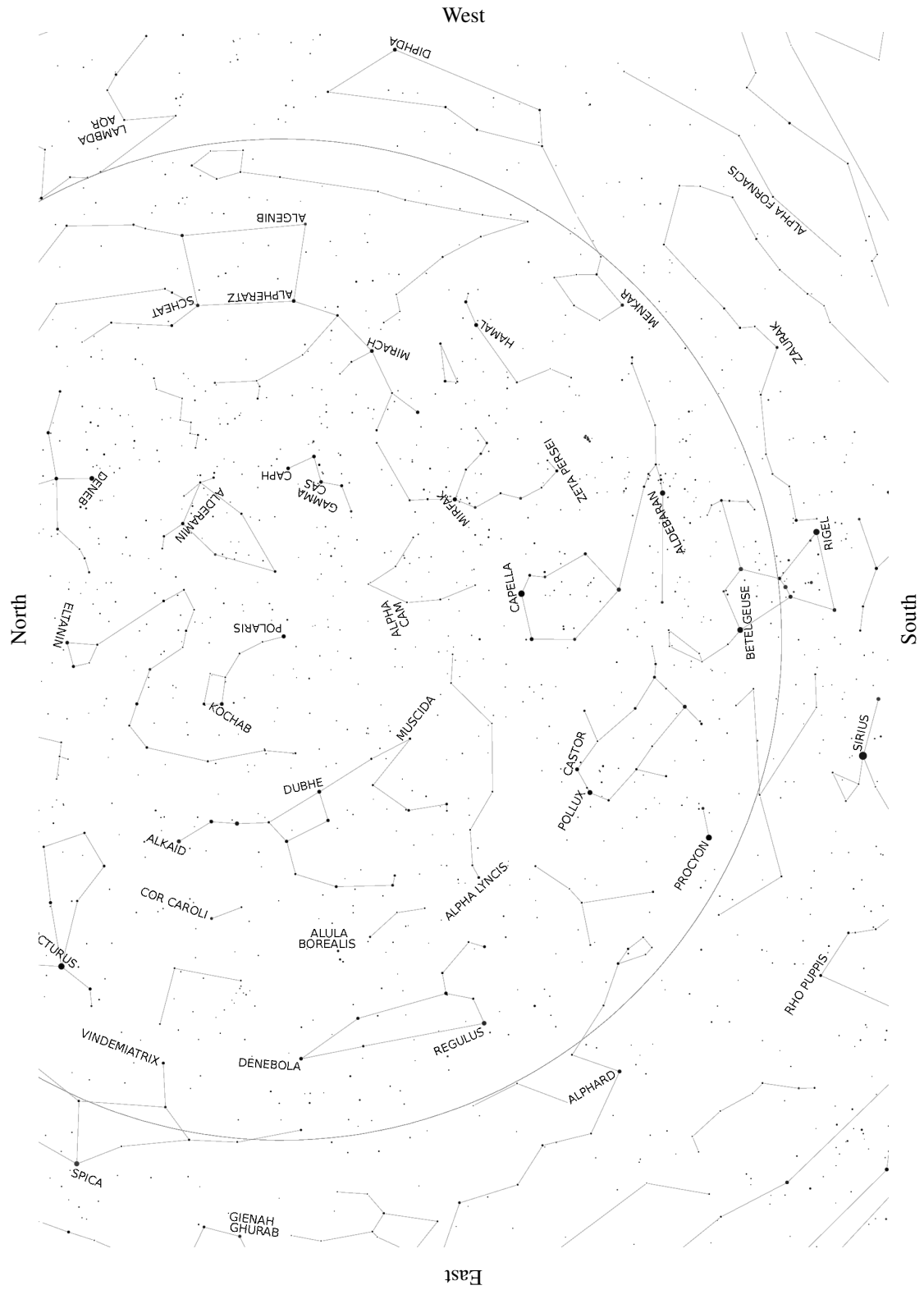

8.3.5 Southern Hemisphere Chart – March to May

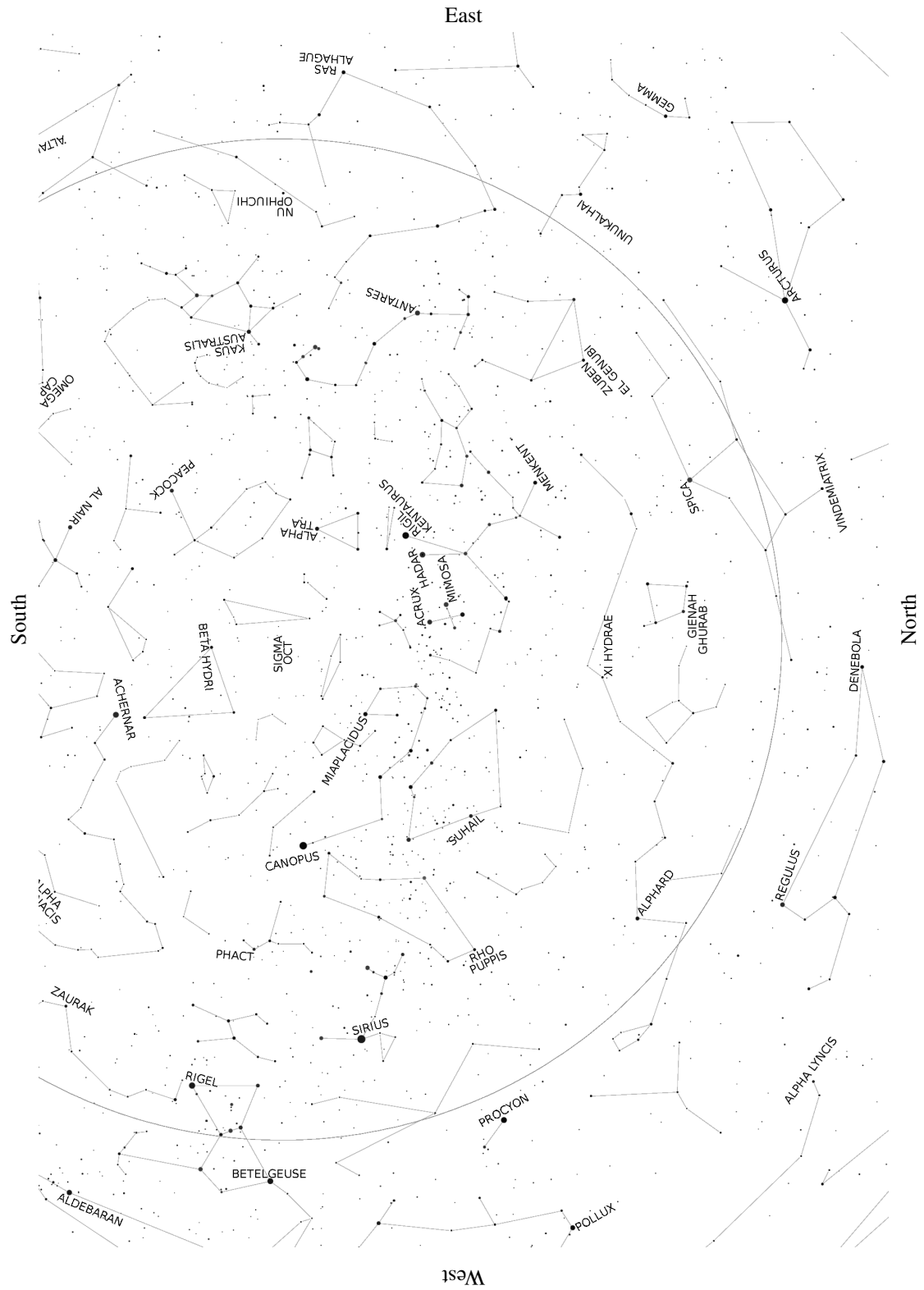

8.3.6 Southern Hemisphere Chart – June to August

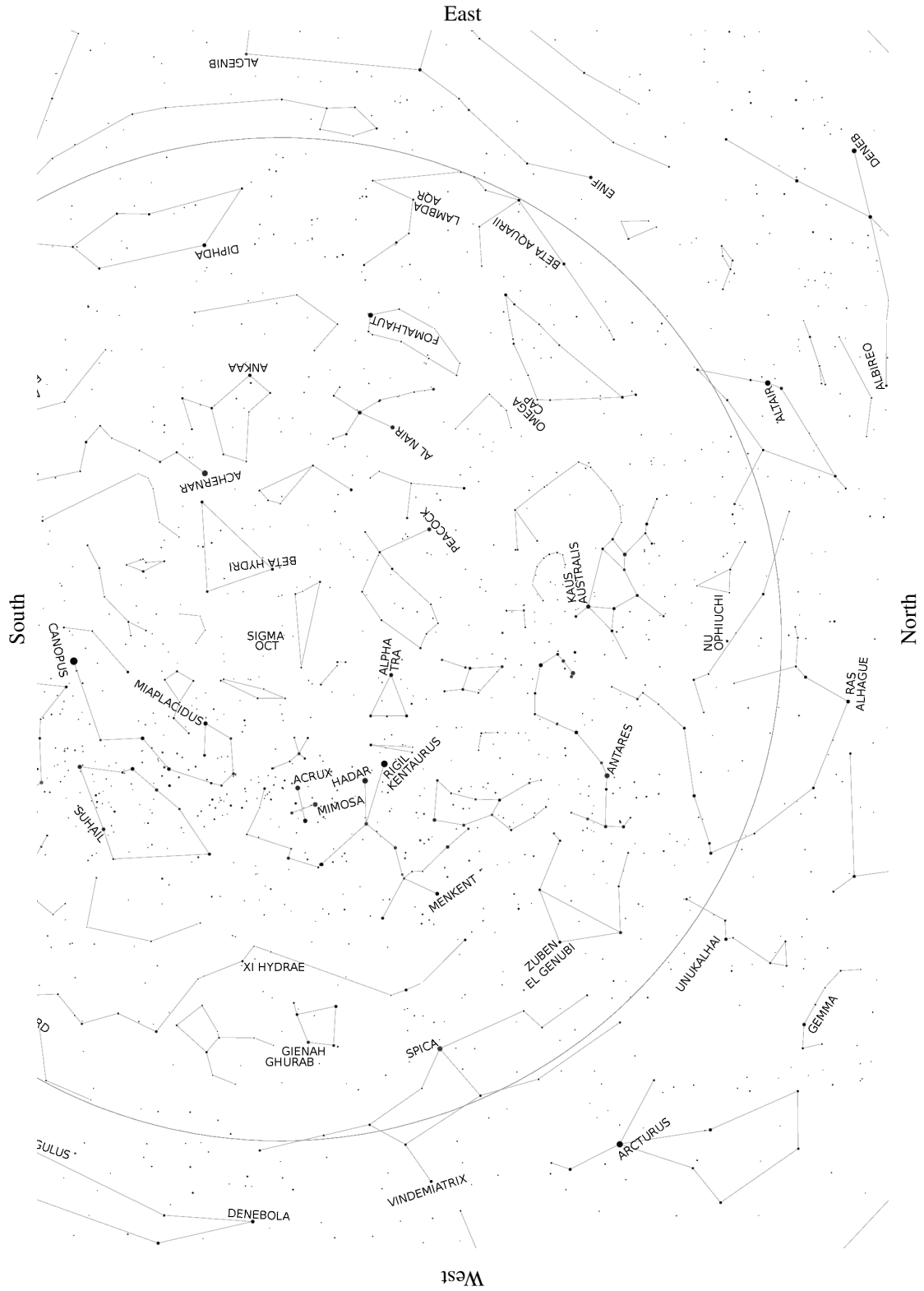

8.3.7 Southern Hemisphere Chart – September to November

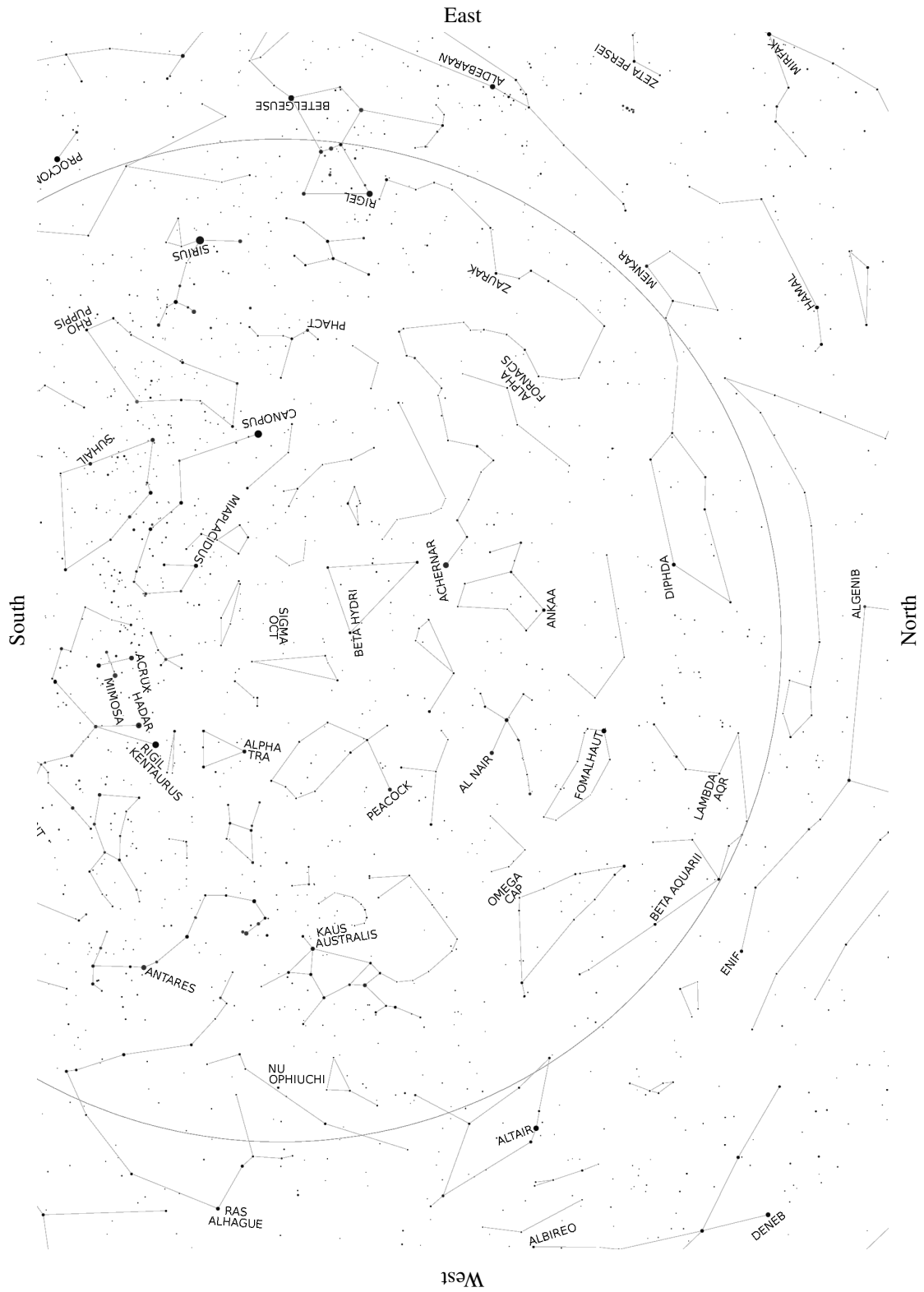

8.3.8 Southern Hemisphere Chart – December to February

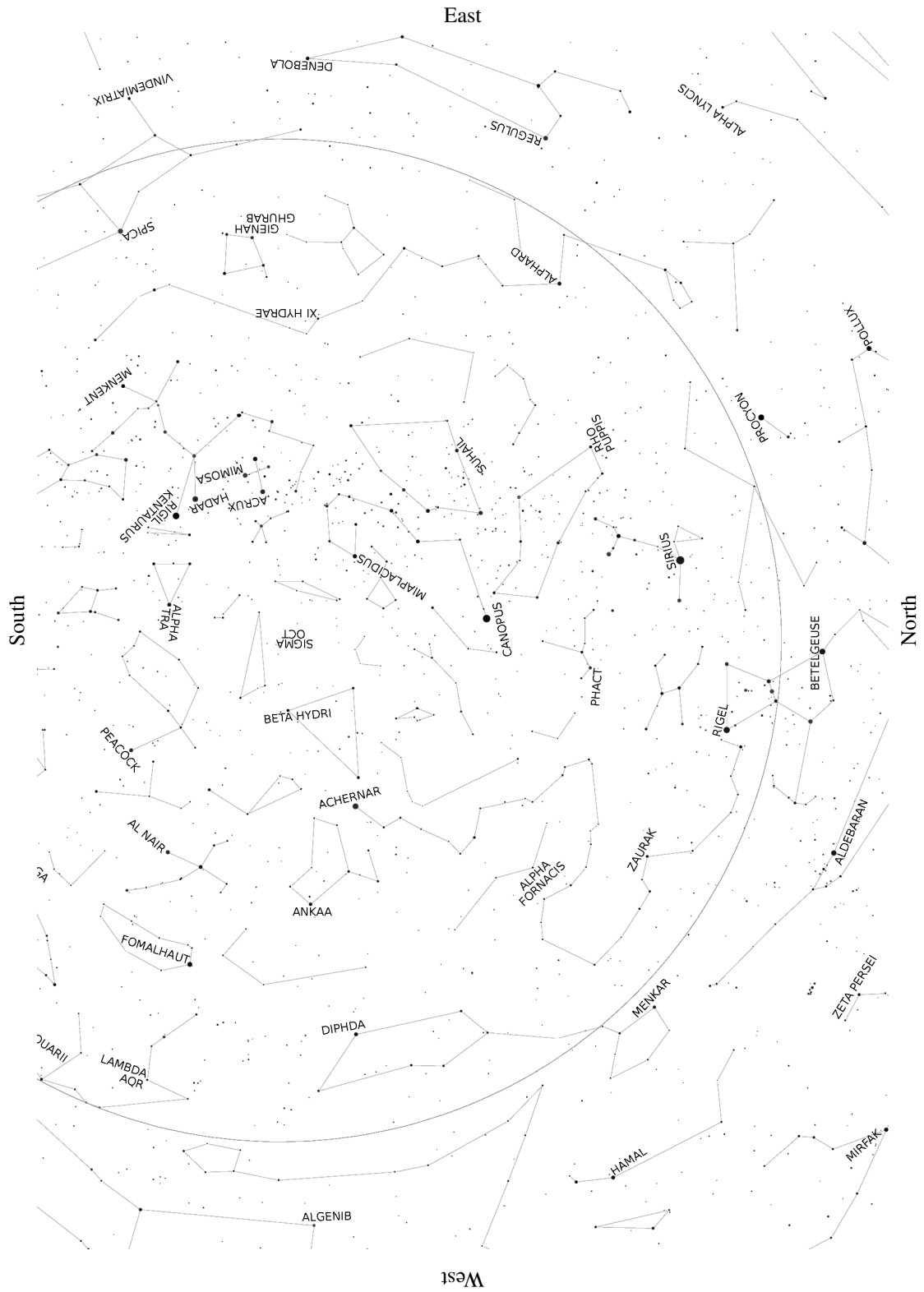

9 Remote Control

The GM2000HPS II mount can be controlled from a remote PC in a number of ways. You can use the Virtual Keypad software, provided by 10micron, to emulate the functions of the keypad, or control the mount with many popular software packages. This can be done through the GPS/RS-232 port or the LAN port.

Through these ports you can also upgrade the firmware of the mount.



WARNING

This system does not know if the telescope or some other instrument collides with the mount or other obstructions when moving. The software will slew to the correct side of the meridian (with an user-configurable tolerance), will perform some checks and will disallow aiming under the horizon (with an user-configurable tolerance) when the alignment has been done correctly.

You should pay attention when the telescope is moving in order to avoid problems to the telescope, its accessories and cables. Additional care should be used when the mount is operated remotely. In this case, a webcam or surveillance camera could be a good idea to check that everything is OK.

9.1 Configuration

The configuration to use depends on the selected port (RS-232 or LAN). In order to use the RS-232 connection, you will need the GPS to RS-232 adapter.

9.1.1 RS-232 Serial Connection

The serial interface of the PC is connected to the GPS/RS-232 interface of the control box (see chapter 5.1.1). No additional configuration is required.

9.1.2 Ethernet or Wireless LAN

Various connections are possible. The mount can be inserted into an existing network, connecting the LAN socket of the control box with a switch/router using a CAT.5 pin-to-pin cable.

Otherwise, the mount can be connected directly with a PC network socket, using a CAT.5 crossover cable. A standard CAT.5 cable can be up to 100m long.

If the wireless option is installed, the mount can be connected to an existing or ad-hoc network, or it can be used as an hotspot to connect other devices. The relevant settings are explained in paragraph 6.5.5.

If you connect the mount directly to a PC using a crossover cable, you can set both the PC's and the mount's IP addresses as in the following example.

Using *Windows XP*, click on Start, then select Connect To and Show All Connections. The Network Connections folder opens. Right-click on the Local Area Connection and select Properties. Make sure that the TCP/IP protocol is checked and double click on it. Select "Use the following IP address" and enter IP address **192.168.1.1** and Subnet mask **255.255.255.0**.

Using *Windows 7*, click on Start, open the Control Panel, click on "Network and Internet", then on "Network and Sharing Center", then on "Change adapter settings". Right-click on the "Local Area Connection" and select "Properties". In the window that appears, verify that the TCP/IP protocol is checked, select it and click on "Properties". Select "Use the following IP address" and insert the IP address **192.168.1.1** and the Subnet mask **255.255.255.0**.

Then click on OK in this window and in the Properties window, and close the Network Connections folder.

Using *Windows 8*, type "Network and Sharing Center" in the Search box on the Start panel. "Network and Sharing Center" will appear; click on it. Then click on "Change adapter settings". Right-click on the "Local Area Connection" and select "Properties". In the window that appears, verify that the TCP/IP protocol is checked, select it and click on "Properties". Select "Use the following IP address" and insert the IP address **192.168.1.1** and the Subnet mask **255.255.255.0**.

Then click on OK in this window and in the Properties window, and close the Network Connections folder.

On the Mount, select **MENU - Settings - Network - Config Network - Set IP Address** and enter the following data:

IP address	192.168.001.099
Network mask	255.255.255.000
Gateway	192.168.001.001

If you are connecting the mount to a router or an ADSL modem/router where the PC is already connected, often a DHCP server is available to obtain automatically the configuration information. In order to use the DHCP server, select **MENU - Settings - Network - Config Network - Use DHCP**. The mount will try to obtain the configuration information from the DHCP server. Select **MENU - Settings - Network - Show IP address** and scroll the text with the **+ / -** keys to verify the configuration; note the IP address of the mount.

If you are connecting the mount to a pre-existing network with pre-assigned IP addresses, you will have to enter manually an IP address/subnet mask/gateway which is appropriate for your network.



NOTICE

There are many possible network configurations. These settings are only an example, that may work or not in your particular case.

You can check that the PC and the mount can communicate using the PC command prompt, found under Start – All Programs – Accessories – Command Prompt (Windows XP/7) or pressing the Windows key + X and selecting "Command Prompt" (Windows 8). Type **ping** followed by your mount's IP address (for example **ping 192.168.1.99** and press Enter. You will see an answer similar to this one:

```
Pinging [192.168.1.99] with 32 bytes of data:
Reply from 192.168.1.99: bytes=32 time<1ms TTL=128
Reply from 192.168.1.99: bytes=32 time<1ms TTL=128
Ping statistics for 208.80.152.2:
    Packets: Sent = 2, Received = 2, Lost = 0 (0% loss),
    Approximate round trip times in milli-seconds:
        Minimum = 0ms, Maximum = 0ms, Average = 0ms
```

If you see "Request timed out" then the connection, or the configuration, is incorrect.

If the wireless option is installed, the easiest way to connect one or more wireless devices to the mount is to configure the mount as an access point. Select **MENU - Settings - Wireless - WLAN Hotspot**, and set a name for the wireless network that will be created. Then select the WPA-PSK encryption, and insert a WPA passphrase as you like (note that you will have to insert the passphrase in

every device that will be connected to the mount through the wireless interface). Insert a valid IP address for the mount (for example, **192.168.2.1**) and a network mask (for example **255.255.255.0**).

In order to connect a wireless device to the mount, activate the wireless network scan on the device, and select the network you have created with the mount. The device will ask for the WPA passphrase; insert it and the device will connect to the mount (a few seconds will be required for the mount to assign an IP address to the device).



NOTICE

Since the wireless device won't be able to connect to the Internet using the wireless connection to the mount, warning messages may appear on the device, signalling that the connectivity is limited. This is perfectly normal.

9.2 Controlling the Mount with the Virtual Keypad

The Virtual Keypad software, included in the CD-ROM, simulates a keypad device on a remote control PC.

To install the software, start the executable installer contained in the file `gm_qci_virtkeypad2.x.zip` on the CD-ROM.

9.2.1 Operation

On the PC desktop, click on the "Virtual Keypad" icon to start the software. The main window of the Virtual Keypad software (Fig. 9.1) replicates the keypad.

Click on "Connection" and then on "Settings". A window appears where you can insert the connection parameters. Depending upon the desired connection mode, either select "Serial on RS-232 port" and choose the appropriate COM port (Fig. 9.2), or select "LAN (TCP/IP)" and enter the TCP/IP address of the mount (Fig. 9.3). Confirm the configuration clicking on the "OK" button.



NOTICE

When using the LAN connection, the Virtual Keypad software communicates with the mount using the TCP/IP port number 3491.

Now click on "Connection" and then on "Connect". The connection is established, and the display of the Virtual Keypad software will be updated to reflect the current display of the keypad.

The keypad and the Virtual Keypad operate in parallel, i.e. the display is the same on both devices and pressing a key on the Virtual Keypad has the same effect as pressing a key on the keypad.

The keys of the Virtual Keypad can be pressed by clicking on them with the mouse, or by typing on the keyboard with the following correspondence:

Key on Virtual Keypad	Key on keyboard
N ↑	cursor up

Key on Virtual Keypad	Key on keyboard
E ←	cursor left
W →	cursor right
S ↓	cursor down
ESC	Esc
MENU	F2
STOP	F3
ENTER	Enter
+ ▲	+ or Page Up
- ▼	- or Page Down
0 - LIGHT	0
1 - COORD	1
2 - INFO	2
3 - DISP	3
4 - STAR	4
5 - PLANET	5
6 - MORE	6
7 - M	7
8 - NGC	8
9 - IC	9

Furthermore, you can use the normal a-z alphabetic keys for input into fields that allow letters.

To interrupt the connection, click on “Connection” and then on “Disconnect”. You can then remove the LAN cable or the serial cable.

9.3 Controlling the Mount with Other Software

The GM2000HPS II mount can communicate with other software using the GPS/RS-232 port, and also on the TCP/IP ports 3490 and 3492. The command protocol is a compatible extension of the Meade LX200 protocol. Its use is detailed in the command protocol documentation. In order to increase interoperability with existing software, the communication can be configured to vary the emulation (see paragraph 6.5.3 for details about selecting the emulation).

If you want to use the Ethernet or Wireless connection over port 3490 or 3492 with a software supporting the serial link, you can use a virtual serial port software such as HW Virtual Serial Port (http://www.hw-group.com/products/hw_vsp/index_en.html).

From version 2.10 onwards, you are advised to use the 10micron ASCOM driver for controlling the mount under Windows XP SP3 or above.

Check the ASCOM standards website <http://ascom-standards.org> for information about the ASCOM initiative.

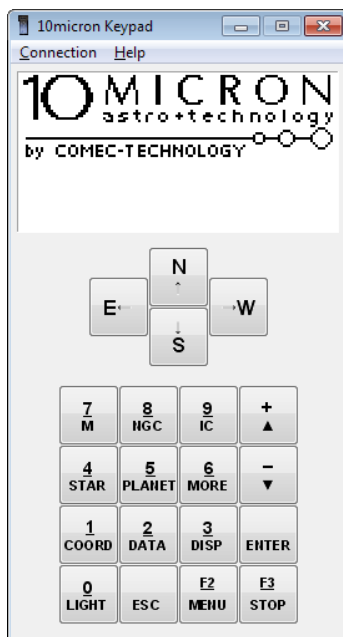

Fig. 9.1: Virtual Keypad software.

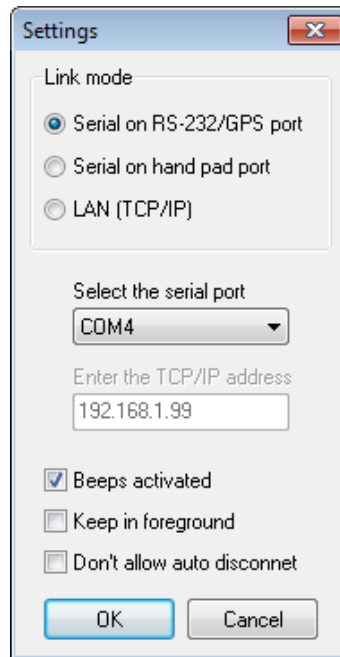

Fig. 9.2: Settings for serial connection.

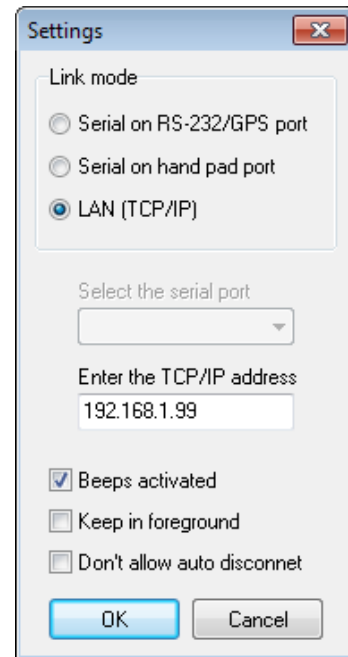

Fig. 9.3: Settings for LAN connection.

9.3.1 Installing and Using the 10micron ASCOM Driver

The 10Micron ASCOM Telescope driver provides ASCOM support for the 10Micron telescope mounts. It will enable ASCOM-compatible clients such as planetarium or camera control software to connect to your mount using the ASCOM interface standard.

Available features will depend on the client software used. In order to use this ASCOM driver with the best results, we invite you to update your mount firmware to the latest version available.

The following is required to install the 10micron ASCOM driver:

- A PC running Microsoft Windows XP SP3 / Vista / 7;
- Microsoft .NET Framework version 3.5;
- the ASCOM Platform version 6.

From your ASCOM client software, select the "10Micron Mount" ASCOM driver using the procedure described in your ASCOM client software's documentation.

The 10Micron ASCOM Telescope driver provides a Settings dialog window where you may configure the following options.

Communication

- RS-232: choose this if your mount is connected to the PC using a serial link cable. Then choose the relevant COM port.
- TCP/IP: choose this if your mount is connected to the PC through a LAN. Insert the IP address of your mount (you may configure or check it using the keypad). Then choose if you want to connect to port 3490 or port 3492. Up to firmware version 2.9.9, the mount will accept only one connection on each port.

Mount Settings

- Slew rate: configure the slew rate, in degrees/s, that your mount will be configured to use after connection.
- Guide rate: configure the guide rate your mount will be configured to use after connection.
- Enable Sync: enable the possibility of synchronizing coordinates using the ASCOM driver. In order to avoid accidentally overwriting the pointing model of the mount, you may choose to enable this function only when building a new pointing model.
- Use Sync as Alignment: configure the Sync commands in the ASCOM interface to make the mount use each additional synchronization as a new point for the pointing model.

Optics Settings These settings are used only in order to provide for the ASCOM properties "ApertureArea", "ApertureDiameter" and "FocalLength". In many circumstances it is safe just to ignore these settings.

9.4 Notes for some Software Packages

The following notes, regarding some software packages, are provided as a quick reference only; see the documentation included with your software for details about its telescope control functions.

9.4.1 Note for "TheSkyX"

In order to use an ASCOM driver, you will need TheSkyX Professional Edition for Windows or TheSkyX Serious Astronomer Edition for Windows, version 10.1.11 or above. You will have then to install the "X2 to ASCOM Converter for TheSkyX" from the ASCOM initiative website.

Start "TheSkyX" and choose from the menu "Telescope → Telescope Setup". In the "Imaging System Setup" window choose "Mount Setup → Choose...", then select "ASCOM → Telescope Driver".

Again in the "Imaging System Setup" window, select "Mount Setup → Settings...". A window will appear, asking you if you wish to read the documentation for the X2/ASCOM driver. Answer "No" in order to proceed to the ASCOM Telescope Chooser window. Select "10Micron Mount" and then "Properties..." to configure the 10Micron ASCOM driver. See the previous paragraph for details.

When the configuration is complete, click on OK in the ASCOM Telescope Chooser window. Then close the Imaging System Setup window.

From the menu, choose "Telescope → Connect". If the message "No response from device" appears, check if you used the correct settings in the 10Micron ASCOM driver, if the cable is connected at both ends and if the electronics is switched on. If the connection is ok, TheSkyX will show the area where the telescope is just pointing at.

If you click on an object with the right mouse button, you can choose the "Slew" command to point at the object.

9.4.2 Note for "Perseus"

Start Perseus and choose from the menu "Telescope control"; select "ASCOM Driver" as telescope type.

The ASCOM Telescope Chooser window appears. Select "10Micron Mount" and then "Properties..." to configure the 10Micron ASCOM driver. See the previous paragraph for details.

When the configuration is complete, click on OK in the ASCOM Telescope Chooser window.

Now the control window will appear and Perseus will be able to control the mount.

9.4.3 Note for "Sky Safari" on Android or iOS

If the wireless option is installed, it is possible to control the mount directly with a wireless device using Sky Safari. Set the wireless connection as described above, and connect the wireless device to the mount (remember that the device won't be able to connect to the Internet through this wireless connection, and it could give warnings about this). Open Sky Safari, select "Settings" and the "Setup" under "Telescope". Set the Scope Type to "Meade LX-200 Classic" or "Astro-Physics GTO", and the Mount Type to "Equatorial GoTo (German)". Set "Connect via WiFi", deselect "Auto-Detect SkyFi", enter the IP address of the wireless interface of the mount and set the Port Number to 3490. Exit from the Configuration screen and tap on "Connect". In a few seconds the mount will be under the control of Sky Safari.



NOTICE

Because of the rapid change of the software industry, the compatibility with the GM2000HPS II mount changes continuously. For information about the command set supported by the RS-232 or LAN link, please contact the assistance at support@10micron.com or the authorised reseller.

9.5 Upgrading the Firmware

The firmware of the GM2000HPS II mount can be upgraded to a new version using the updater software, available from the 10micron website.

To download the updates, go to the URL www.10micron.com/english/support.htm and click "Forum".

You need to register to the forum to download the updates.

The updater software can also be used to update the comets and asteroids databases of the mount.

The instruction manual for the updater is available as a .PDF file after installing the software. Please refer to it for details.

10 Troubleshooting

The software of the GM2000HPS II mount has been carefully tested by several experts. If you still find an error, please tell us. In that case, we need the following information from you:

1. The version number of the software, displayed under **MENU - Settings - Version**.
2. A complete list of all adjusted parameters.
3. A detailed description of how to reproduce the error. A problem can only be resolved if it is reproducible.

If you have a proposal for improving the GM2000HPS II mount, please let us know, also by e-mail at support@10micron.com.

A table of commonly encountered problems (and proposed solutions) follows.

Problem	Cause	Action
The telescope can't slew accurately to an object.	The polar axis is not correctly aligned with the celestial pole.	Repeat the alignment procedure or use the 2-stars alignment.
	The wrong object has been selected.	Select the correct object.
	The telescope has been aligned on the wrong stars.	Repeat the alignment procedure.
	Some parameters (date, time, location, time zone, DST) are not correctly set.	Enter the correct parameters.
	The telescope has a large orthogonality error and the mount has been aligned only with 2 stars or less.	Repeat the alignment using three or more stars.
	The clock battery is exhausted.	Replace the clock battery and enter again the correct time.
The mount stops and the message WARNING LOCK CLUTCHES! appears.	The clutches have been released while slewing or moving at high speed.	Tighten the clutches and try again.
At the end of a 2-stars or 3-stars alignment, the message Align mismatch! Confirm? appears.	The firmware has detected that the mount r.a. axis is far away from the pole (at least about 10 degrees), or that the cone error is extremely large, or some other alignment parameter is unusually off. This may be caused by aligning on the wrong star.	Press ENTER and do a polar alignment afterwards. If the r.a. axis is already aligned with the celestial pole, press ESC and realign, being careful to align with the correct stars. Otherwise, check that the telescope has the correct orientation on the declination axis flange.
The clock is wrong.	The DST setting is wrong.	Check if the DST is underway and adjust appropriately the DST setting of the mount.
	The clock battery is exhausted.	Replace the clock battery and enter again the correct time.

Problem	Cause	Action
The motors halt and the MOTOR ERROR – CHECK POWER message appears.	The power supply is inadequate.	Check that the power supply is able to provide the required current.
The telescope hits an obstacle or the base of the mount.	The alignment is incorrect.	Repeat the alignment procedure.
	The Flip Slew Tolerance and Flip Guide Tolerance parameters are set to a value that is too large.	Set the Flip Slew Tolerance and Flip Guide Tolerance to a smaller value.
The message Can't balance: meridian blocked appears when starting the balance procedure.	The mount has been configured to stay on one side of the meridian.	Change the setting in the menu Drive – Meridian side to Both .
The message Horizon limit too high appears when starting the balance procedure.	The mount can't point at the celestial pole since the horizon limit is equal or greater than the absolute value of your geographical latitude.	Set the horizon limit in the menu Drive – Horizon limit to a value smaller than the absolute value of your geographical latitude.
The mount freezes and the message HW ERROR code XX.XX.XX.XX.XX appears.	A cable is loose or disconnected.	Switch off the mount, check carefully all connections and try again.
	The motor is pushing towards an unexpected obstacle.	Switch off the mount, check that the mount can move around and try again.
	The mount is extremely unbalanced.	Switch off the mount, check the balance in both axes and try again.
	A fault inside the mount has been detected.	Contact the customer assistance providing the error code.
The mount freezes and the message ERROR! CAN'T COM WITH MOUNT appears.	The mount connection cable is loose or disconnected.	Switch off the mount, check carefully all connections and try again.

11 Maintenance

Under normal operating conditions, minimal maintenance is required.

Every 12 months clean the external surfaces from dust and, if you want, lightly grease all surfaces with a soft cloth to protect the surface colour treatment of the mount. We recommend using Vaseline oil.

Remove humidity.

The internal parts are greased for the entire life of the mount and, under normal operating conditions, no other maintenance is required. After 10 years you can think to do a total maintenance of all internal gearing, but we suggest to do it with an expert or if you prefer by our maintenance department.

No checks or periodical corrections are needed.

12 Technical Support Centre

If any problem occurs, please don't hesitate to contact the reseller or dealer in your country or directly our technical support department, also on our web site at:

www.10micron.com/english/support.htm

Don't hesitate to contact us for assistance:

10 MICRON by

COMEC – via Archimede 719

21042 Caronno Pertusella (VA) – ITALY

In foreign countries: for any technical or maintenance problem or problems regarding spare parts, please contact the manufacturer or authorized dealer in the country of import, who will tell you what steps to take or will refer you to qualified maintenance centres.



WARNING

The company cannot be held responsible for any damage caused by operations effected by staff who have not first contacted the Technical Assistance Centres or who have not been authorized by the manufacturer's assistants.

The warranty and CE conformity declaration are included in the mount package.



IMPORTANT NOTE

The original shipping cardboard with shaped foams *MUST* be kept in order to get any warranty and it must be used in case of return of the mount for repair. *Sending the mount in any packaging other than the original one voids the warranty.* The manufacturer, the dealer and the reseller cannot be held responsible for any further damage caused by failing to observe the above statements. Warranty is ex-headquarters of the manufacturer company – Comec snc – Italy. Any cost of returning the goods is at customer's charge even if in warranty period.

Please provide us with the serial number of your mount when requesting assistance. You can find the serial number in the inner part of the support shoulders, as shown in Fig. 12.1.



Fig. 12.1: Location of the serial number.

13 Menu Structure

Use this reference table to find the relevant information for each command in the menu of the keypad.

The main menu is composed of five items: Objects, Alignment, Drive, Local Data, Settings.

13.1 Objects

Menu	Submenu	Notes	Paragraph
Deepsky	Messier	Messier catalogue	6.1.1
	NGC	New General Catalogue	6.1.1
	IC	Index Catalogue	6.1.1
	PGC	Principal Galaxy Catalogue	6.1.1
	UGC	Uppsala General Catalogue of galaxies	6.1.1
Star	Name	Proper name	6.1.2
	Bayer	Bayer letter and constellation	6.1.2
	Flamsteed	Flamsteed number and constellation	6.1.2
	BSC	Bright Star Catalogue (also HR, Harvard Revised)	6.1.2
	SAO	Smithsonian Astrophysical Observatory	6.1.2
	HIP	Hipparcos Catalogue	6.1.2
	HD	Henry Draper catalogue	6.1.2
	PPM	Position and Proper Motions catalogue	6.1.2
	ADS	Aitken Double Star catalogue	6.1.2
GCVS	General Catalogue of Variable Stars	6.1.2	
Planet	0 Sun		6.1.3
	1 Mercury		6.1.3
	2 Venus		6.1.3
	3 Moon		6.1.3
	4 Mars		6.1.3
	5 Jupiter		6.1.3
	6 Saturn		6.1.3
	7 Uranus		6.1.3
	8 Neptune		6.1.3
9 Pluto		6.1.3	
Moon feature	Select feature	Choose a feature on the Moon	6.1.4
	Coordinates	Aim at lunar coordinates	6.1.4
	Terminator	Aim at lunar terminator	6.1.4
	Selection	Configure the selection of lunar features	6.1.4
	Sync on feature	Synchronize the mount on a lunar feature	6.1.4
	Clear sync	Clear the lunar feature synchronization	6.1.4

Menu	Submenu	Notes	Paragraph
Asteroid	1 Ceres 2 Pallas ..	Select from the list or enter the official number	6.1.5
Comet	1P Halley 2P Encke ..	Select from the list or enter the official number	6.1.6
Coordinates		Enter RA and declination coordinates to slew to	6.1.7
User defined	Select user obj Add user obj Delete user obj	Select an object from the user database Add an object to the user database Delete an object from the user database	6.1.8 6.1.8 6.1.8
Alt/Az Coords		Enter altazimuth coordinates to slew to	6.1.9
Meridian Flip		When in the proximity of the meridian, moves the telescope to the other side of the mount, pointing at the same point in the sky	6.1.10
Satellite	Satellite Find Next passes	Select a satellite from the list Select a satellite passing in the next minutes	6.1.11 6.1.11

13.2 Alignment

Menu	Submenu	Notes	Paragraph
Park/Unpark		Park or unpark the mount	5.7
Park position	Stops only	Parking stops the mount in the current position	6.2.2
	Default park	Parking slews the mount to the default park position	6.2.2
	Custom park 1	Parking slews the mount to the custom park position 1	6.2.2
	Custom park 2	Parking slews the mount to the custom park position 2	6.2.2
	Custom park 3	Parking slews the mount to the custom park position 3	6.2.2
	Set custom pos1	Set the current position as the custom park position 1	6.2.2
	Set custom pos2	Set the current position as the custom park position 2	6.2.2
	Set custom pos3	Set the current position as the custom park position 3	6.2.2
Polar Iterate		Align the polar axis using Polaris and another star	5.5.5
2-Stars		Align the mount using two stars as reference objects	5.5.1
Refine Stars		Add a star as reference object for calibrating the mount	5.5.3
3-Stars		Align the mount using three stars as reference objects	5.5.2
Delete star		Delete an alignment star from the mount model	6.2.7
Align Database	Load model	Save the current alignment in the database	6.2.8
	Save model	Load an alignment from the database	6.2.8
	Delete model	Delete an alignment from the database	6.2.8
Clear align		Deletes the current alignment information	5.4.1
Polar Align		Align the polar axis using the alignment data and without Polaris	5.5.4
Ortho Align		Correct the orthogonality error of the telescope	5.5.6
Align Info		Show various data on the current alignment	5.5.7
Sync Refines		Configure the synchronization command	6.2.13

Menu	Submenu	Notes	Paragraph
Boot Align	Stay Parked	After booting, the mount will stay parked regardless of the state it was switched off	6.2.14
	Last Status	after booting, the mount will stay in the same state it was switched off	6.2.14
	Alw. Unpark	after booting, the mount will be always unparked, regardless of the state it was switched off.	6.2.14

13.3 Drive

Menu	Submenu	Notes	Paragraph
Tracking Speed	Sidereal	Sidereal tracking speed	6.3.1
	Solar	Solar tracking speed	6.3.1
	Lunar	Lunar tracking speed	6.3.1
	Custom	Custom tracking speed, entered by the user	6.3.1
	Stop	Tracking stopped	6.3.1
Dual tracking		Activate dual axis tracking	6.3.2
Swap E-W		Exchange the action of the E – W direction keys	6.3.3
Swap N-S		Exchange the action of the N – S direction keys	6.3.4
Auto Swap N-S		Exchange automatically the action of the N – S direction keys, depending on the meridian side	6.3.5
Corr. Speed		Activate the $\cos \delta^{-1}$ correction for manual movements and autoguiding	6.3.6
Slew Rate		Set the maximum slew speed, between 2°/s and 20°/s	6.3.7
Autoguide speed		Sets the autoguide correction speed	6.3.8
Tracking corr		Set a correction to the tracking speed	6.3.9
Flip Slew Tol		Define the angular limit to which the telescope will slew going beyond the meridian from the “wrong” side of the mount (max. 30°, default 10°)	6.3.10
Flip Guide Tol		Define the angular limit to which the telescope will track objects beyond the meridian (max. 30°, default 20°)	6.3.11
Horizon Limit		Set the minimum elevation for slews, from -5° to +45°	6.3.12
Track warn		If this option is active, beeps when the tracking time left is expiring	6.3.13
Follow Obj		Set to ON to compute and set automatically the tracking rate after each slew to a solar system object	6.3.14

Menu	Submenu	Notes	Paragraph
Balance	Balance RA	Swings the telescope up and down to verify balancing (right ascension axis)	6.3.15
	Balance Dec	Swings the telescope up and down to verify balancing (declination axis)	6.3.15
	Conf balance	Set to ON to confirm each step of the balancing procedure	6.3.15
	Set bal. speed	Adjusts the balance speed	6.3.15
	Use slew speed	Sets the balance speed equal to the slew speed	6.3.15
Meridian side	Both	Allows the scope to point to both sides of the meridian	6.3.16
	West	Restricts the scope to west of the meridian	6.3.16
	East	Restricts the scope to east of the meridian	6.3.16
	Set this side	Restricts the scope to the current side of the meridian	6.3.16

13.4 Local Data

Menu	Submenu	Notes	Paragraph
Clock	Date and Time	Enter the date and time	6.4.1
	Local Timezone	Set the local time zone (positive east of Greenwich)	6.4.1
	DST	Daylight Saving Time correction	6.4.1
Site	Current	Show the current observation site data	6.4.2
	Select	Select the observation site from the database	6.4.2
	Enter	Enter the coordinates of the observation site	6.4.2
	Save	Save the current observation site in the user database	6.4.2
	Delete	Delete an observation site from the user database	6.4.2
Use GPS Data		Set date, time and geographical coordinates from the optional GPS module	6.4.3
Boot GPS Sync		Search the optional GPS module when the mount is switched on	6.4.4
GPS-UTC diff		Show the GPS-UTC time difference	6.4.5
Refraction	Show Current	Show the current refraction data	6.4.6
	Set Temperature	Enter the air temperature	6.4.6
	Set Pressure	Enter the atmospheric pressure in hPa	6.4.6
	Set Pressure 0	Enter the atmospheric pressure at sea level in hPa	6.4.6
	Auto Press	Compute the pressure from elevation	6.4.6

13.5 Settings

Menu	Submenu	Notes	Paragraph
User Interface	Brightness	Set the brightness of the display	6.5.1
	Contrast	Set the contrast of the display	6.5.1
	Beep	Activate or deactivate the sound from the keypad	6.5.1
	Boot Display	Select what to display after switching on the mount	6.5.1
GPS Port	GPS	Use the GPS/RS-232 port to get data from a GPS	6.5.2
	Serial	Use the GPS/RS-232 port as a RS-232 port for remote control	6.5.2
	Dome	Use the GPS/RS-232 port for dome control	6.5.2
Emulation	Emul. LX200N	Emulate the native LX200 protocol (increased compatibility with software coded for Meade controllers)	6.5.3
	Emul. LX200X	Emulate the extended LX200 protocol (increased compatibility with software coded for Astro-Physics controllers)	6.5.3
Network	Show IP address	Show the current network configuration	6.5.4
	Config Network	Enter the network configuration	6.5.4
Wireless (only if the wireless option is installed)	WLAN Client	Configure the wireless interface as a client.	6.5.5
	WLAN Hotspot	Configure the wireless interface as a hotspot.	6.5.5
	WLAN Off	Shut down the wireless interface.	6.5.5
	WLAN Purge	Delete all information about the wireless networks.	6.5.5
	Show WLAN Info	Show current data about the wireless configuration.	6.5.5
Asteroid Filter	Filter	Activate or deactivate the asteroid brightness filter	6.5.6
	Limit magnitude	Set the magnitude limit for the asteroid filter	6.5.6
Comet Filter	Filter	Activate or deactivate the comet brightness filter	6.5.7
	Limit magnitude	Set the magnitude limit for the comet filter	6.5.7
Shutdown		Shuts down the mount	6.5.8

Menu	Submenu	Notes	Paragraph
Dome	Open Shutter	Open the dome shutter	6.5.9
	Close Shutter	Close the dome shutter	6.5.9
	Home	Force homing of the dome	6.5.9
	Dome Control	Dome control parameters	6.5.9
	Mount Position	Mount position parameters	6.5.9
	Scope Offset	Scope position parameters	6.5.9
	Park close	Close the dome shutter when parking	6.5.9
	Unpark open	Open the dome shutter when unparking	6.5.9
Version		Show the version and date of the firmware, and the version of the motors' firmware	6.5.10
Security	Unlock advanced	Unlock the advanced functions.	6.5.12
	Lock advanced	Lock the advanced functions.	6.5.12
	Set PIN	Set the PIN for unlocking the advanced functions.	6.5.12
Language		Change the language used on the keypad	6.5.11

14 Technical Drawings

14.1 Base Adapter

All quotes are in mm.

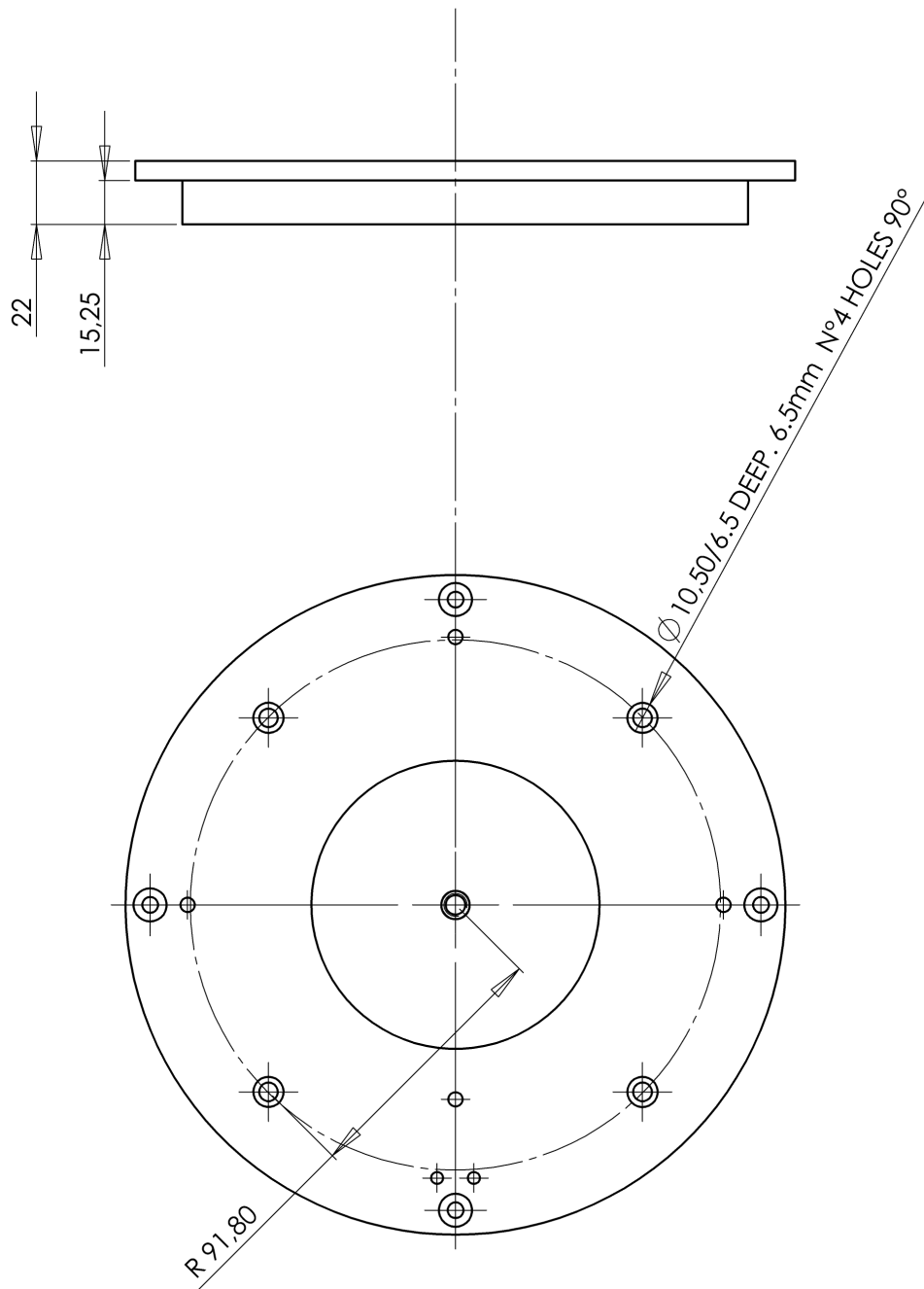

14.2 Tripod Adapter (optional)

All quotes are in mm.

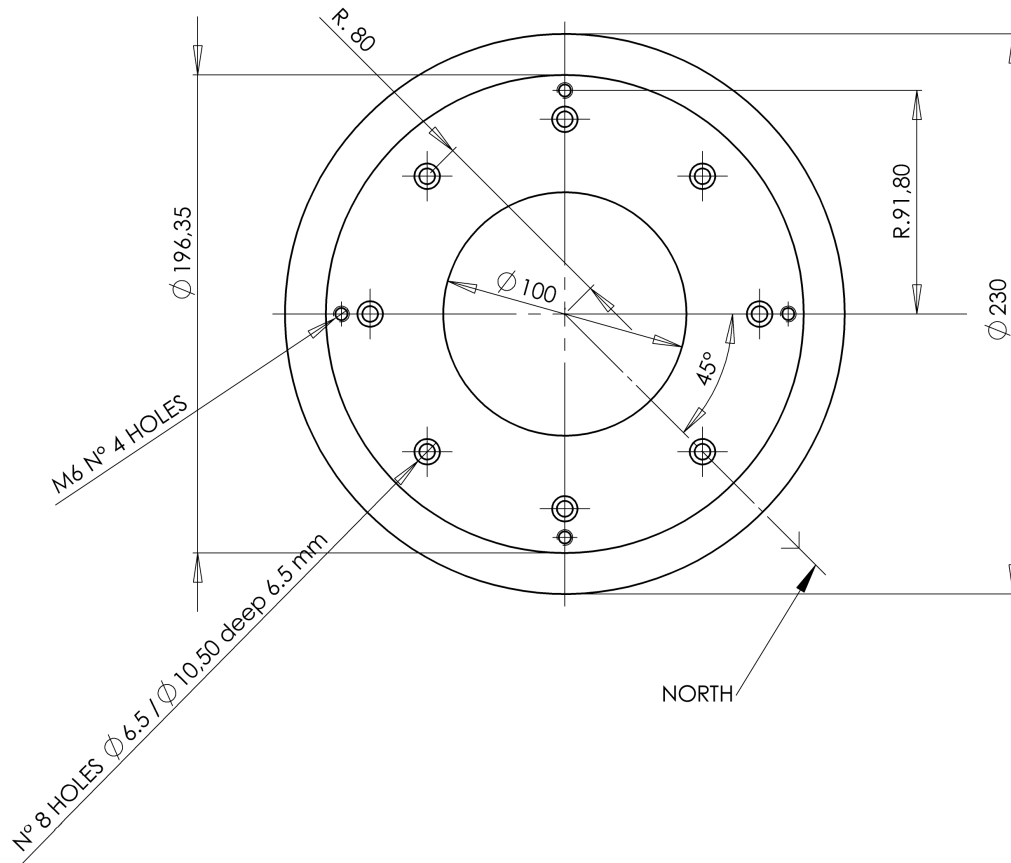

14.3 Telescope Flange

All quotes are in mm.

